

The TikZ-Extensions Package
Manual for version 0.5.1
<https://github.com/Qrrbrbirlbel/tikz-extensions>

Qrrbrbirlbel

April 2, 2023

Contents

I	Introduction	5
1	Usage	5
2	Why do we need it?	5
3	Having problems?	5
II	TikZ Libraries	6
4	Calendar	7
4.1	Value-keys and nestable if key	7
4.2	PGFmath functions	7
4.3	Week numbering (ISO 8601)	7
5	Layers	8
5.1	Internal keys	8
5.2	User-level keys	8

6	Node Families	9
6.1	Text Box	9
6.2	Minimum Width/Height	10
6.3	More shapes that support the keys width and height	11
7	Nodes	12
7.1	Pic as a node	12
7.2	Nodes on paths	12
7.2.1	Nodes on Lines	12
7.2.2	Nodes on Curves	13
8	Arc to a point	14
9	More Horizontal and Vertical Lines	16
9.1	Zig-Zag	16
9.2	Zig-Zig	18
9.3	Even more Horizontal and Vertical Lines	19
10	Extending the Path Timers	21
10.1	Rectangle	21
10.2	Parabola	22
10.3	Sine/Cosine	22
11	Using Images as a Pattern	24
12	Positioning Plus	25
12.1	Useful corner anchors	25
12.2	Useful placement keys for vertical and horizontal alignment	26
13	Scaling Pictures to a Specific Size	30
13.1	Keeping the aspect ratio	30
13.2	Changing the aspect ratio.	30
14	Arcs through Three Points	32
15	Mirror, Mirror on the Wall	33
15.1	Using the reflection matrix	33
15.2	Using built-in transformations	34

III	PGF Libraries	36
16	Arrow Tips	37
16.1	Centered	38
16.1.1	Barbed Arrow Tips	38
16.1.2	Geometric Arrow Tips	38
16.1.3	Special Arrow Tips	38
16.2	Untipped	39
16.2.1	Barbed Arrow Tips	39
16.2.2	Geometric Arrow Tips	39
16.3	Original Arrow Tips	39
17	Transformations: Mirroring	41
17.1	Using the reflection matrix	41
17.2	Using built-in transformations	41
18	Shape: Circle Arrow	43
19	Shape: Circle Cross Split	46
20	Shape: Heatmark	49
21	Shape: Rectangle with Rounded Corners	52
22	Shape: Superellipse	54
23	Shape: Uncentered Rectangle	57
IV	Utilities	60
24	Calendar: Weeknumbers and more conditionals	61
24.1	Extensions	61
24.2	Week numbering (ISO 8601)	62
25	Repeating Things and Other Things	63

26	And a little bit more	65
26.1	PGFmath	65
	26.1.1 Postfix operator R	65
	26.1.2 Functions	65
	26.1.3 Functions: using coordinates	66
26.2	PGFfor	66
26.3	PGFkeys	67
	26.3.1 Conditionals	67
	26.3.2 Handlers	67
26.4	TikZ	69
V	Changelog, Index & References	70
	Changelog	70
	Index	72
	References	83

Part I

Introduction

1 Usage

This package is called `tikz-ext`, however, one can't load it via `\usepackage`.¹ Instead, this package consists mostly of `pgf` and `TikZ` libraries which are loaded by either `\usepgflibrary` or `\usetikzlibrary`.

2 Why do we need it?

Since I have been answering questions on [TeX.sx](https://tex.stackexchange.com/) I've noticed that some questions come up again and again, every time with a slightly different approach on how to

solve them.

I don't like reinventing the wheel which is why I've gathered the solutions of my answers in this package.

3 Having problems?

Note however, that most of these extensions haven't been stress-tested properly and might be considered experimental.

Don't hesitate to open an issue on GitHub. You probably found a bug.

¹Except for `calendar-ext` and `pgffor-ext`.

4 Calendar

TikZ Library `ext.calendar-plus`

```
\usetikzlibrary{ext.calendar-plus} % LATEX and plain TEX
\usetikzlibrary[ext.calendar-plus] % ConTEXt
```

This library extends the TikZ library calendar.

Q & A: [10, 11, 4] & [26, 46, 44]

4.1 Value-keys and nestable if key

The values of following keys are originally stored in some macros that are not accessible by the user. These are now simple value-keys. The @-protected macros are still available, of course.

`/tikz/day xshift` (initially 3ex)

`/tikz/day yshift` (initially 3.5ex)

`/tikz/month xshift` (initially 9ex)

`/tikz/month yshift` (initially 9ex)

It is now also possible to nest `/tikz/if` occurrences.

`/tikz/if=(<conditions>)<code or options>else<else code or options>` (no default)

4.2 PGFmath functions

`weeksinmonthofyear(first weekday, month, year)`

`\pgfmathweeks in month of year{first weekday}{month}{year}`

Returns the number of (partial) weeks in the month *month* of year *year* when this month begins on a *first weekday*.

`lastdayinmonthofyear(month, year)`

`\pgfmathlastday in month of year{month}{year}`

Returns the last day (28, 29, 30 or 31) of month *month* of year *year*.

4.3 Week numbering (ISO 8601)

The actual week number algorithm is implemented by the `pgfcalendar-ext` package/module in section 24.2.

`/tikz/week code=<code>` (no default)

Works like `/tikz/day code` or `/tikz/month code`, only for weeks.

`/tikz/week text=<text>` (no default)

Works like `/tikz/day text` or `/tikz/month text`, only for weeks.

`/tikz/every week` (style, no value)

Works like `/tikz/every day` or `/tikz/every month`, only for weeks.

`/tikz/week label left` (style, no value)

Places the week label to the left of the first day of the month. (For `week list` and `month list` where a week does not start on a Monday, the position is chosen “as if” the week had started on a Monday – which is usually exactly what you want.)

July						
26		1	2	3		
27	4	5	6	7	8	9 10
28	11	12	13	14	15	16 17
29	18	19	20	21	22	23 24
30	25	26	27	28	29	30 31

```
\usetikzlibrary {ext.calendar-plus}
\tikz
\calendar[
  week list, month label above centered,
  dates=2022-07-01 to 2022-07-31,
  week label left,
  every week/.append style={
    gray!50!black, font=|sfamily|};
```

5 Layers

TikZ Library `ext.layers`

```
\usetikzlibrary{ext.layers} % LATEX and plain TEX
\usetikzlibrary[ext.layers] % ConTEXt
```

This library extends TikZ’s functionalities to put nodes, edges, matrices and pics on a separate layer without having to use the `pgfonlayer` environment.

Consider this library experimental. If you can, avoid it and use the `pgfonlayer` environment or change the drawing order.

5.1 Internal keys

`/tikz-ext/patch=<specification>` (no default)

Since this library is experimental, its functionality needs to be activated explicitly. The `<specification>` is one of

- `node`,
- `matrix`,
- `pic`²,
- `edge` or
- `all` which applies all the patches at once.

These keys only work when a patch is applied but don’t need to be used since the patching activated specific

`/tikz-ext/layers/in box=<box>` (no default)

`/tikz-ext/layers/on layer=<layer>` (no default)

5.2 User-level keys

`/tikz/node on layer=<layer>` (no default)

`/tikz/node in box=<box>` (no default)

`/tikz/matrix on layer=<layer>` (no default)

`/tikz/matrix in box=<box>` (no default)

`/tikz/edge on layer=<layer>` (no default)

`/tikz/edge in box=<box>` (no default)

`/tikz/pic on layer=<layer>` (no default)

`/tikz/pic in box=<box>` (no default)

²Only the normal `/tikz/pics/code` can be placed on different layers. Both `/tikz/pics/background code` and `/tikz/pics/foreground code` will not be affected.

6 Node Families

TikZ Library `ext.node-families`

```
\usetikzlibrary{ext.node-families} % LATEX and plain TEX
\usetikzlibrary[ext.node-families] % ConTEXt
```

With this library the user can instruct multiple nodes to have the same width, height, text width, text height or text width. This uses the hook `/tikz/execute at end picture` to write the nodes' measurements to the AUX file.

Unfortunately, this does not work with the external library.³

Q & A: [13] & [29]

Before we get to the interesting keys, a common prefix can be set for the families' names. Initially this is `\pgfpictureid-` so that families of different pictures don't interact.

```
/tikz/node family/prefix=<prefix> (no default, initially \pgfpictureid-)
```

The family names are prefixed with the value of `/tikz/node family/prefix`.

6.1 Text Box

The following keys – when setup, see below – work with every shape with one single node part.⁴ Initially though, only `circle` and `rectangle` are set up that way.

```
/tikz/node family/text height=<name> (no default, initially {})
```

Nodes with the same `<name>` will have the same text height. An empty `<name>` disables the evaluation by the library.

```
/tikz/node family/text depth=<name> (no default, initially {})
```

Nodes with the same `<name>` will have the same text depth. An empty `<name>` disables the evaluation by the library.

```
/tikz/node family/text width=<name> (no default, initially {})
```

Nodes with the same `<name>` will have the same text width. An empty `<name>` disables the evaluation by the library.

```
/tikz/node family/text=<name> (no default)
```

Sets `text height`, `text depth` and `text width`.

Since the width of the node's content's box is setup much earlier, the previous key only extends the width of that box which would make the text seem as if it were aligned to the left. With `text width family align` this can be changed.

³First of all, I can't figure out how to use the AUX file during externalization since it gets written to the LOG instead. And then there's the question about how `external` would notice the need to export the picture again until it's stable ...

⁴Technically, it will also work with shapes with multiple node parts but it will only affect the main node part.

`/tikz/node family/text width align=<alignment>`

(no default, initially center)

<alignment> is one of left, center or right.

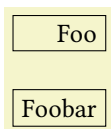

```
\usetikzlibrary {positioning,ext.node-families}
\tikzexternaldisable % ext.node-families does not work with active externalization
\begin{tikzpicture}[nodes={rectangle, draw, node family={text width=manual, text width align=right}}]
\node (a) {Foo};
\node[below=of a] (b) {Foobar};
\end{tikzpicture}
```

`/tikz/node family/setup shape=<shape>`

(no default)

This adds instructions to the <shape>'s definition which adjust the text box's dimensions according to the family.

This should be only used once per shape.

6.2 Minimum Width/Height

While the keys of the previous subsection work well enough for nodes of the same shape (and the same inner seps), for different node shapes the text box dimensions will be used differently for the node's total dimension.

For this, the following keys are necessary. When one of the keys are used the values of minimum width and/or minimum height are set to `nf_width` or `nf_height` respectively.

`/tikz/node family/width=<name>`

(no default, initially {})

Nodes with the same <name> will have the same `/pgf/minimum width`. An empty <name> disables the evaluation by the library.

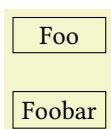

```
\usetikzlibrary {positioning,ext.node-families}
\tikzexternaldisable % ext.node-families does not work with active externalization
\begin{tikzpicture}[nodes={rectangle, draw, node family/width=manual}]
\node (a) {Foo};
\node[below=of a] (b) {Foobar};
\end{tikzpicture}
```

`/tikz/node family/height=<name>`

(no default, initially {})

Nodes with the same <name> will have the same `/pgf/minimum height`. An empty <name> disables the evaluation by the library.

`/tikz/node family/size=<name>`

(no default)

Sets both height and width.

6.3 More shapes that support the keys width and height

TikZ Library `ext.node-families.shapes.geometric`

```
\usetikzlibrary{ext.node-families.shapes.geometric} % LATEX and plain TEX  
\usetikzlibrary[ext.node-families.shapes.geometric] % ConTEXt
```

This library adds support for the keys `/tikz/node family/width` and `/tikz/node family/height` for the shapes of the PGF library `shapes.geometric`.

Q: [21]

The shapes are also setup for the keys from subsection 6.1.

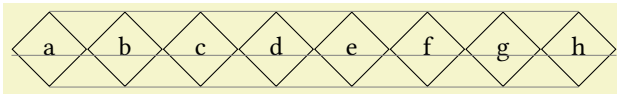

```
\usetikzlibrary {ext.node-families.shapes.geometric}  
\tikzexternaldisable % ext.node-families does not work with active externalization  
\begin{tikzpicture}  
\foreach \cnt[count=\Cnt] in {a,...,h}  
  \node[draw, diamond, node family/text=aT0h] (\cnt)  
    at (right:\Cnt) {\cnt};  
\draw[help lines] (a.south) -- (h.south) (a.north) -- (h.north) (a.base-|a.west) -- (h.base-|h.east);  
\end{tikzpicture}
```

7 Nodes

TikZ Library `ext.nodes`

```
\usetikzlibrary{ext.nodes} % LATEX and plain TEX
\usetikzlibrary[ext.nodes] % ConTEXt
```

This library extends TikZ's functionalities when it comes to nodes.

Q & A: [9, 17] & [30, 39]

7.1 Pic as a node

`/tikz/pic=<boolean>` (default true, initially false)

This key allows one to use a pic where usually only nodes are accepted, for example as a label.

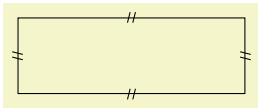

```
\usetikzlibrary {ext.nodes, ext.misc}
\begin{tikzpicture}[
  s!s!/.pic={\draw(-2pt, 1.5pt)--( 2pt, .5pt)
             ( 2pt,-1.5pt)--(-2pt,-.5pt);}]
\node[
  draw, minimum width=3cm, minimum height=1cm,
  label={[pic] east:s!s!},
  label={[pic, rotate= 90]north:s!s!},
  label={[pic] west:s!s!},
  label={[pic, rotate=-90]south:s!s!}]{};
\end{tikzpicture}
```

7.2 Nodes on paths

When nodes are placed along paths they don't interrupt the path at that place. The decoration markings and its `/pgf/decoration/mark connection node` key can help but only works for straight paths and doesn't play nicely with arrow tips.

This library provides alternatives. These are separated into straight paths, i. e. `- -`, and everything else (including any `to` path).

7.2.1 Nodes on Lines

`/tikz/node on line=<anchor specification>` (style, default `{}`)

This installs a `/tikz/to` path that places *one* node along a straight line but connect the line with it.

This allows a node to be placed *on* a straight line without having to use `fill = white` or similar tricks to make the line disappear beneath the node.

The optional `<anchor specification>` allows to specify the anchors to which the line should connect. It allows one or two anchors divided by `and` to be specified.

`/tikz/nodes on line` (style, no value)

This is similar to the previous key but allows multiple nodes to be placed on a straight line *if* they are in the correct order (from start to target), don't overlap with each other, the start or the target.

It allows *no* anchor specification.

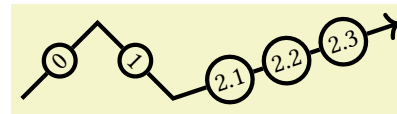

```
\usetikzlibrary {ext.nodes, quotes}
\tikz[inner sep=.15em, circle, nodes=draw, sloped]
\draw[ultra thick, ->, node on line] (0,0) to["0"] (1,1)
                                         to["1"] (2,0)
                                         to[nodes on line, "2.1" near start, "2.2", "2.3" near end] (5,1);
```

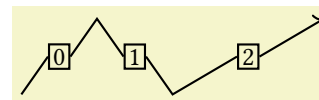

```
\usetikzlibrary {ext.nodes, quotes}
\tikz[inner sep=.15em, nodes=draw]
\draw[thick, ->, node on line=west and east]
(0,0) to["0"] (1,1)
      to["1"] (2,0)
      to["2"] (4,1);
```

7.2.2 Nodes on Curves

The following keys need the intersections and the spath3 [51] library to be loaded. They will not be automatically loaded by this library.

Any `/pgf/outer sep` will be ignored.

If you can, use `fill=(bg color)` instead of these keys, it will be much faster and easier.

`/tikz/nodes on curve=(to path)` (style, default line to)

Similar to `/tikz/nodes on line`, this key allows to have nodes on arbitrary paths.

This is not suitable for paths connecting nodes.

`/tikz/nodes on curve'=(to path)` (style, default line to)

As above but suitable for connecting nodes.

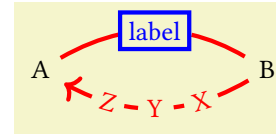

```
\usetikzlibrary {ext.nodes, intersections, quotes, spath3}
\begin{tikzpicture}[ultra thick]
  \node (A) at (0, 0) {A};
  \node (B) at (3, 0) {B};
  \draw [red, ->, nodes on curve'=bend left]
    (A) to node[blue,draw]{label} (B)
    to ["X" {sloped, near start},
        "Z" {sloped, near end},
        "Y" ] (A);
\end{tikzpicture}
```

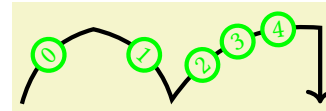

```
\usetikzlibrary {ext.nodes, intersections, quotes, spath3}
\tikz[inner sep=.15em, circle, nodes={draw, green}, sloped, ultra thick]
\draw[->, nodes on curve=bend left] (0,0) to["0"] (1,1)
to["1"] (2,0)
to["2" near start, "3", "4" near end] (4,1)
-- ++(down:1);
```

8 Arc to a point

TikZ Library `ext.paths.arcto`

```
\usetikzlibrary{ext.paths.arcto} % LATEX and plain TEX
\usetikzlibrary[ext.paths.arcto] % ConTEXt
```

This library adds the new path operation `arc to` to that specifies an arc *to* a point – without the user having to specify any angles.

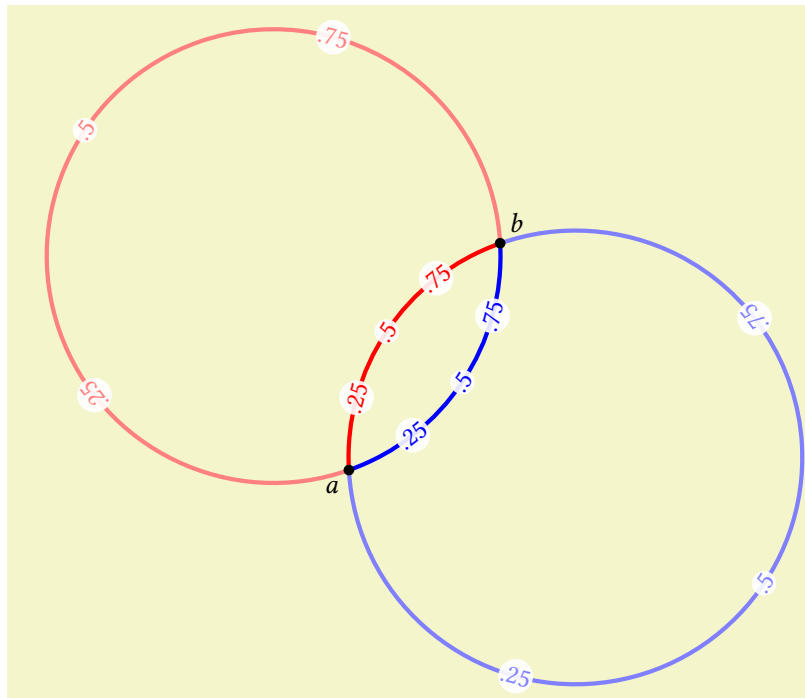

```
\usetikzlibrary {ext.paths.arcto}
\begin{tikzpicture}[ultra thick,dot/.style={label={#1}}]
\coordinate[dot=below left:$a$] (a) at (0,0);
\coordinate[dot=above right:$b$] (b) at (2,3);
\begin{scope}[
  radius=3,
  nodes={
    shape=circle,
    fill=white,
    fill opacity=.9,
    text opacity=1,
    inner sep=+0pt,
    sloped,
    allow upside down
  }]
\draw[blue] (a) arc to[]
  node[near start] {.25} node {.5} node[near end] {.75} (b);
\draw[red] (a) arc to[clockwise]
  node[near start] {.25} node {.5} node[near end] {.75} (b);
\draw[blue!50] (a) arc to[large]
  node[near start] {.25} node {.5} node[near end] {.75} (b);
\draw[red!50] (a) arc to[large, clockwise]
  node[near start] {.25} node {.5} node[near end] {.75} (b);
\end{scope}

\fill[radius=2pt] (a) circle[] (b) circle[];
\end{tikzpicture}
```

`\path ... arc to[options](coordinate or cycle) ...;`

When this operation is used, the path gets extended by an arc that goes through the current point and `(coordinate)`.

For two points there exist two circles or four arcs that go through or connect these two points. Which one of these is constructed is determined by the following options that can be used inside of `(options)`.

`/tikz/arc to/clockwise`

(style, no value)

This constructs an arc that goes clockwise.

`/tikz/arc to/counter clockwise`

(style, no value)

This constructs an arc that goes counter clockwise.

This is the default.

`/tikz/arc to/large`

(style, no value)

This constructs an arc whose angle is larger than 180°.

`/tikz/arc to/small`

(style, no value)

This constructs an arc whose angle is smaller than 180°.

`/tikz/arc to/rotate=<degree>`

(no default)

Rotates the arc by *<degree>*. This is only noticeable when *x radius* and *y radius* are different.

`/tikz/arc to/x radius=<value>`

(no default)

This forwards the *<value>* to `/tikz/x radius`. Its *<value>* is used for the radius of the arc.

`/tikz/arc to/y radius=<value>`

(no default)

This forwards the *<value>* to `/tikz/y radius`. Its *<value>* is used for the radius of the arc.

`/tikz/arc to/radius=<value>`

(no default)

This forwards the *<value>* to both `/tikz/x radius` and `/tikz/y radius`. Its *<value>* is used for radius of the arc.

`/tikz/every arc to`

(style, no value)

After `/tikz/every arc to` this will also be applied before any *<options>* are set.

It should be noted that this uses `\pgfpatharcto` for which the TikZ manual warns:

The internal computations necessary for this command are numerically very unstable. In particular, the arc will not always really end at the <target coordinate>, but may be off by up to several points. A more precise positioning is currently infeasible due to T_EX's numerical weaknesses. The only case it works quite nicely is when the resulting angle is a multiple of 90°.

The `arc to path` operation will also work only in the canvas coordinate system. The lengths of the vectors (1, 0) and (0, 1) will be used for the calculation of the radii but no further consideration is done.

9 More Horizontal and Vertical Lines

TikZ Library `ext.paths.ortho`

```
\usetikzlibrary{ext.paths.ortho} % LATEX and plain TEX  
\usetikzlibrary[ext.paths.ortho] % ConTEXt
```

This library adds new path specifications `| - |`, `- | -` as well as `r-ud`, `r-du`, `r-lr` and `r-rl`.

9.1 Zig-Zag

Similar to the path operations `| -` and `- |` this library adds the path operations `| - |` and `- | -`.

```
\path ... | - | [options] <coordinate or cycle> ...;
```

This operation means “first vertical, then horizontal and then vertical again”.

```
\path ... - | - [options] <coordinate or cycle> ...;
```

This operation means “first horizontal, then vertical and then horizontal again”.

```
/tikz/ortho/ratio=<ratio>
```

(no default, initially 0.5)

This sets the ratio for the middle part of the Zig-Zag connection.

For values $\langle ratio \rangle < 0$ and $\langle ratio \rangle > 1$ the Zig-Zag lines will look more like Zig-Zig lines.

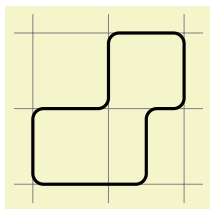

```
\usetikzlibrary {paths.ortho}  
\begin{tikzpicture}[very thick, rounded corners]  
\draw[help lines] (-.25, -1.25) grid (2.25, 1.25);  
\draw (0, 0) | - | (2, 1) --  
      (2, 0) - | - [ratio=.25] (0,-1) -- cycle;  
\end{tikzpicture}
```

```
/tikz/ortho/distance=<distance>
```

(no default)

This sets the distance between the start point and the middle part of the Zig-Zag connection.

For values $\langle distance \rangle < 0$ the distance will be used for the target coordinate.

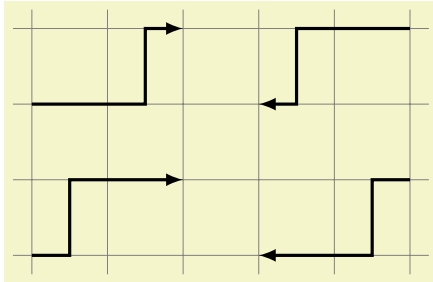

```

\usetikzlibrary {ext.paths.ortho}
\begin{tikzpicture}[very thick,-latex]
\draw[help lines,-] (-.25, -.25) grid (5.25, 3.25);
\draw (0, 0) -|-[distance=.5cm] ++(2, 1);
\draw (0, 2) -|-[distance=-.5cm] ++(2, 1);

\tikzset{xshift=3cm}
\draw (2, 1) -|-[distance=.5cm] ++(-2, -1);
\draw (2, 3) -|-[distance=-.5cm] ++(-2, -1);
\end{tikzpicture}

```

`/tikz/ortho/from center=<true or false>`

(default true)

When nodes get connected the placement of the middle part of the Zig-Zag and the Zig-Zig (see below) connections will be calculated from the border of these nodes. The middle part of the connections can be calculated from the nodes' center if this key is set to true.

New timers are setup for both the Zig-Zag and the Zig-Zig connections, these can be configured through the following keys.

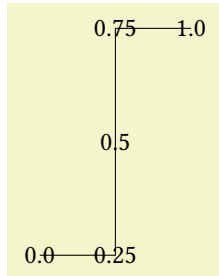

```

\usetikzlibrary {paths.ortho}
\tikz \draw (0,0) -|-(2,3)
  foreach \p in {0.0, 0.25, 0.5, 0.75, 1.0}{
    node [pos=\p] {\p}};

```

`/tikz/ortho/spacing=<number>`

(no default, initially 4)

Unless *<number>* = 0 is set

- pos = 0 will be at the start,
- pos = 1 will be at the end,
- pos = $\frac{1}{\langle number \rangle}$ will be at the first kink,
- pos = $\frac{\langle number \rangle - 1}{\langle number \rangle}$ will be at the second kink and
- pos = .5 will be in the middle of the middle part of the connection.

If $\langle number \rangle = 0$ then

- $pos = -1$ will be at the start,
- $pos = 2$ will be at the end,
- $pos = 0$ will be at the first kink,
- $pos = 1$ will be at the second kink and
- $pos = .5$ will still be in the middle of the middle part of the connection.

`/tikz/ortho/middle 0 to 1`

(no value)

This is an alias for `spacing = 0`.

9.2 Zig-Zig

`\path ... r-ud[$\langle options \rangle$] $\langle coordinate or cycle \rangle$...;`

This operation means “first up, then horizontal and then down”.

`/tikz/ortho/ud distance= $\langle length \rangle$`

(no default, initially .5cm)

This sets the distance between the start and the horizontal line to $\langle length \rangle$.

`\path ... r-du[$\langle options \rangle$] $\langle coordinate or cycle \rangle$...;`

This operation means “first down, then horizontal and then up”.

`/tikz/ortho/du distance= $\langle length \rangle$`

(no default, initially .5cm)

This sets the distance between the start and the horizontal line to $\langle length \rangle$.

`\path ... r-lr[$\langle options \rangle$] $\langle coordinate or cycle \rangle$...;`

This operation means “left down, then vertical and then right”.

`/tikz/ortho/lr distance= $\langle length \rangle$`

(no default, initially .5cm)

This sets the distance between the start and the vertical line to $\langle length \rangle$.

`\path ... r-rl[$\langle options \rangle$] $\langle coordinate or cycle \rangle$...;`

This operation means “first right, then vertical and then down”.

`/tikz/ortho/rl distance= $\langle length \rangle$`

(no default, initially .5cm)

This sets the distance between the start and the vertical line to $\langle length \rangle$.

All distances can be set with one key.

`/tikz/ortho/udlr distance= $\langle length \rangle$`

(no default)

Sets all the previous distances to the same value $\langle length \rangle$.

9.3 Even more Horizontal and Vertical Lines

The following keys can be used to access vertical and horizontal line path operations.

`/tikz/horizontal vertical` (style, no value)

This installs to `path = -| (\tikztotarget) \tikztonodes` that can be used with the path operations `to` or `edge`.

`/tikz/vertical horizontal` (style, no value)

This installs to `path = |- (\tikztotarget) \tikztonodes` that can be used with the path operations `to` or `edge`.

`/tikz/horizontal vertical horizontal` (style, no value)

This installs to `path = -|- (\tikztotarget) \tikztonodes` that can be used with the path operations `to` or `edge`.

`/tikz/vertical horizontal vertical` (style, no value)

This installs to `path = |-| (\tikztotarget) \tikztonodes` that can be used with the path operations `to` or `edge`.

When connecting rectangular nodes, these keys could be useful as well. They all need to be given to a `to` or `edge` path operation.

`/tikz/only vertical second=<length>` (style, default 0pt)

This draws a vertical line from the start point to the target point so that it connects to the target point in the center (or at its border in case it is a node).

The optional `<length>` can be used to shift the line orthogonally to its direction.

`/tikz/only horizontal second=<length>` (style, default 0pt)

This draws a horizontal line from the start point to the target point so that it connects to the target point in the center (or at its border in case it is a node).

The optional `<length>` can be used to shift the line orthogonally to its direction.

`/tikz/only vertical first=<length>` (style, default 0pt)

This draws a vertical line from the start point to the target point so that it connects to the start point in the center (or at its border in case it is a node).

The optional `<length>` can be used to shift the line orthogonally to its direction.

`/tikz/only horizontal first=<length>` (style, default 0pt)

This draws a horizontal line from the start point to the target point so that it connects to the start point in the center (or at its border in case it is a node).

The optional `<length>` can be used to shift the line orthogonally to its direction.

Since all previous key are rather cumbersome, one can install shortcuts for these.

```
/tikz/ortho/install shortcuts
```

(style, no value)

Installs the following shortcuts:

```
| - → vertical horizontal  
- | → horizontal vertical  
- | - → horizontal vertical horizontal  
| - | → vertical horizontal vertical  
| * → only vertical first  
* | → only vertical second  
- * → only horizontal first  
* - → only horizontal second
```

10 Extending the Path Timers

TikZ Library `ext.paths.timer`

```
\usetikzlibrary{ext.paths.timer} % LATEX and plain TEX  
\usetikzlibrary[ext.paths.timer] % ConTEXt
```

This library adds timers to the path specifications `rectangle`, `parabola`, `sin` and `cos`.

Q & A: [6, 5] & [36, 48]

In TikZ, the path specification `rectangle`, `parabola`, `sin` and `cos` do not provide their own timer, i. e. a node placing algorithm that is dependent on the actual path. For `rectangle` the timer of the straight line between the rectangle's corners is used, for the other paths, nodes, coordinates, pics, etc. are placed on the last coordinate.

This library allows this.

10.1 Rectangle

For the `rectangle` path operator, the timer starts with `pos = 0` (= at start) from the starting coordinate in a counter-clockwise direction along the rectangle. The corners will be at positions 0.0, 0.25, 0.5, 0.75 and 1.0.

`/tikz/rectangle timer=line or rectangle`

(default rectangle)

By default, the library activates the new (correct) timer for `rectangle`. With `rectangle timer = line` the original line timer can be reinstated.

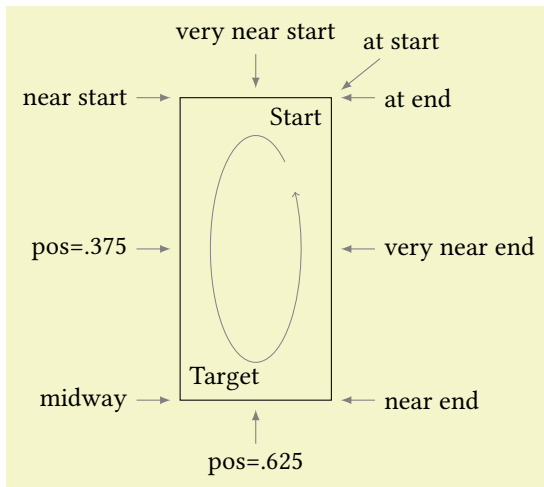

```
\usetikzlibrary {ext.paths.timer}  
\begin{tikzpicture}[scale=2, every pin edge/.style={latex-, gray}]  
\coordinate [label=above right:Target] (A) at (0,0);  
\coordinate [label=below left:Start] (B) at (1,2);  
\draw[->, help lines] ([shift=(50:.3 and .75)] .5,1)  
  arc[start angle=50, delta angle=340, x radius=.3, y radius=.75];  
\draw (B) rectangle (A)  
  foreach \pos/\ang in {at start/60, very near start/90, near start/180, pos=.375/180,  
    midway/180, pos=.625/270, near end/0, very near end/0, at end/0}{  
    node[pin=\ang:\pos, style/.expanded=\pos]{}; }  
\end{tikzpicture}
```

10.2 Parabola

For the parabola path operator the timer is similar to the `.. controls ..` operator.

The position 0.5 will lie at the bend.

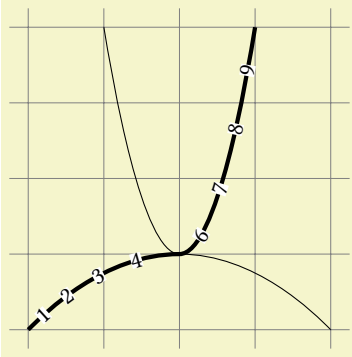

```
\usetikzlibrary {ext.paths.timer}
\begin{tikzpicture}
\draw[help lines] (-2.25, -1.25) grid (2.25, 3.25);
\draw (2,-1) parabola bend (0,0) (-1,3);
\draw[ultra thick] (-2,-1) parabola bend (0,0) (1,3)
  foreach \pos in {1,...,4,6,7,...,9}{
    node[
      pos=. \pos, sloped, fill=white, font=\small, inner sep=+0pt
    ] {\pos}
  };
\end{tikzpicture}
```

If no bend is specified half the positions will collapse into one end of the curve.

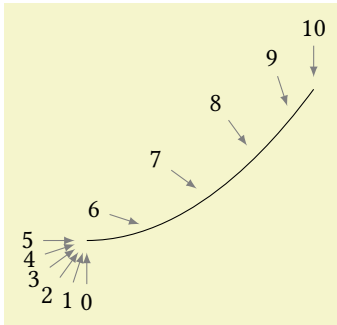

```
\usetikzlibrary {ext.paths.timer}
\begin{tikzpicture}[every pin edge/.style={latex-, shorten <=1pt, gray}]
\draw (-2,-2) parabola (1,0)
  foreach \pos in {0, 1, ..., 10} {
    node [pos=\pos/10, pin={[anchor=-18*\pos+90]-18*\pos+270:\pos]}{}
  };
\end{tikzpicture}
```

10.3 Sine/Cosine

The `sin` and `cos` path operators also allow placing of nodes along their paths.

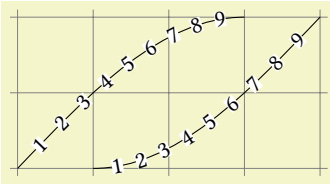

```

\usetikzlibrary {ext.paths.timer}
\begin{tikzpicture}[mark nodes on line/.style={insert path={
  foreach \pos in {1, ..., 9} {node[
    sloped, fill=white, font=\small, inner sep=+0pt, pos=\pos/10] {\pos}}}}]
\draw[help lines] (-2.1,-2.1) grid (2.1,0.1);
\draw (-2,-2) sin (1,0) [mark nodes on line];
\draw[shift=(0:1)](-2,-2) cos (1,0) [mark nodes on line];
\end{tikzpicture}

```

11 Using Images as a Pattern

TikZ Library `ext.patterns.images`

```
\usetikzlibrary{ext.patterns.images} % LATEX and plain TEX  
\usetikzlibrary[ext.patterns.images] % ConTEXt
```

This library allows to use an image to be used as a repeating pattern for a path.

Q & A: [16] & [47]

With this library arbitrary images (or indeed PDF documents) can be used as a repeating pattern for the background of a path. This is a two-step process:

1. Declaring an image as an “image-pattern”.
2. Using the “image-pattern”.

```
\pgfsetupimageaspattern[<options>]{<name>}{<image>}
```

```
/tikz/image as pattern=<options>
```

(default {})

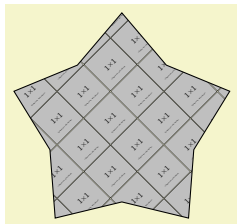

```
\usetikzlibrary {ext.patterns.images,shapes.geometric}  
\pgfsetupimageaspattern[width=.5cm]{grid}{example-image-1x1}  
\tikz \node[star, minimum size=3cm, draw,  
image as pattern={name=grid,options={left, bottom, y=-.5cm, rotate=45}}] {};
```

```
/tikz/image as pattern/name=<name>
```

(no default)

Specifies the name of the “image-pattern” to be used.

```
/tikz/image as pattern/option
```

(style, no value)

Options that will be used by the internal `\pgftext`, only keys from `/pgf/text` should be used.

```
/tikz/image as pattern/options=<style>
```

(style, no default)

Appends style `/tikz/image as pattern/option`.

12 Positioning Plus

TikZ Library `ext.positioning-plus`

```
\usetikzlibrary{ext.positioning-plus} % LATEX and plain TEX  
\usetikzlibrary[ext.positioning-plus] % ConTEXt
```

With the help of the `positioning` and the `fit` library this extends the placement of nodes.

12.1 Useful corner anchors

The anchors `corner north east`, `corner north west`, `corner south west` and `corner south east` are defined as “generic anchors”, i. e. they are defined for all shapes. This is mostly useful for the placement of circular shapes.

`/tikz/corner above left=<specification>` (style, default 0pt)

Similar as `/tikz/above left` of the TikZ library `positioning` but uses the `corner north west` anchor.

`/tikz/corner below left=<specification>` (style, default 0pt)

Similar as `/tikz/below left` of the TikZ library `positioning` but uses the `corner south west` anchor.

`/tikz/corner above right=<specification>` (style, default 0pt)

Similar as `/tikz/above right` of the TikZ library `positioning` but uses the `corner north east` anchor.

`/tikz/corner below right=<specification>` (style, default 0pt)

Similar as `/tikz/below right` of the TikZ library `positioning` but uses the `corner south east` anchor.

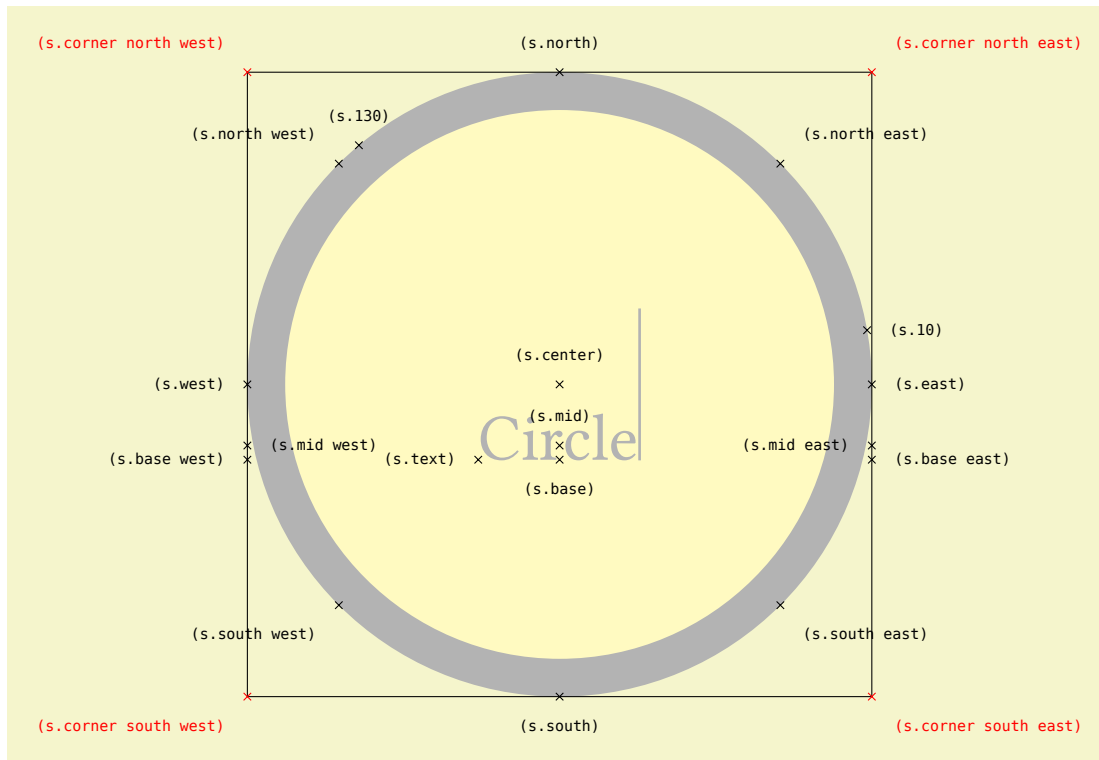

```

\usetikzlibrary {ext.positioning-plus}
\Huge
\begin{tikzpicture}
\node[name=s,shape=circle,shape example]
  {Circle\vrule width 1pt height 2cm};
\foreach \anchor/\placement in {
  north west/above left, north/above, north east/above right,
  west/left, center/above, east/right,
  mid west/right, mid/above, mid east/left,
  base west/left, base/below, base east/right,
  south west/below left, south/below, south east/below right,
  text/left, 10/right, 130/above}
  \draw[shift=(s.\anchor)] plot[mark=x] coordinates{(0,0)}
  node[\placement] {\scriptsize\texttt{(s.\anchor)}};
\draw (s.corner north west) rectangle (s.corner south east);
\foreach \anchor/\placement in {
  corner north west/above left, corner north east/above right,
  corner south west/below left, corner south east/below right}
  \draw[red,shift=(s.\anchor)] plot[mark=x] coordinates{(0,0)}
  node[\placement] {\scriptsize\texttt{(s.\anchor)}};
\end{tikzpicture}

```

12.2 Useful placement keys for vertical and horizontal alignment

`/tikz/north left=<specification>`

(style, default 0pt)

Like `/tikz/left` but aligns the nodes at their north border.

This is basically the same as `left=of reference.north west, anchor=north east`.

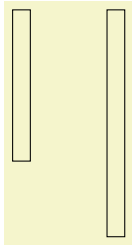

```
\usetikzlibrary {ext.positioning-plus}
\begin{tikzpicture}[nodes=draw]
\node[minimum height=2cm] (a) {};
\node[minimum height=3cm, north right=of a] {};
\end{tikzpicture}
```

`/tikz/north right=<specification>`

(style, default 0pt)

Like `/tikz/right` but aligns the nodes at their north border.

This is basically the same as `left=of reference.north east, anchor=north west`.

`/tikz/south left=<specification>`

(style, default 0pt)

Like `/tikz/left` but aligns the nodes at their south border.

This is basically the same as `left=of reference.south west, anchor=south east`.

`/tikz/south right=<specification>`

(style, default 0pt)

Like `/tikz/right` but aligns the nodes at their south border.

This is basically the same as `left=of reference.south east, anchor=south west`.

`/tikz/west above=<specification>`

(style, default 0pt)

Like `/tikz/above` but aligns the nodes at their west border.

This is basically the same as `left=of reference.north west, anchor=south west`.

`/tikz/west below=<specification>`

(style, default 0pt)

Like `/tikz/below` but aligns the nodes at their west border.

This is basically the same as `left=of reference.south west, anchor=north west`.

`/tikz/east above=<specification>`

(style, default 0pt)

Like `/tikz/above` but aligns the nodes at their east border.

This is basically the same as `left=of reference.north east, anchor=south east`.

`/tikz/east below=<specification>`

(style, default 0pt)

Like `/tikz/below` but aligns the nodes at their east border.

This is basically the same as `left=of reference.south east, anchor=north east`.

The same exist for the recently introduces corner anchors, too.

`/tikz/corner north left=<specification>` (style, default 0pt)

The same as `/tikz/north left` but uses the new corner anchors.

`/tikz/corner north right=<specification>` (style, default 0pt)

The same as `/tikz/north right` but uses the new corner anchors.

`/tikz/corner south left=<specification>` (style, default 0pt)

The same as `/tikz/south left` but uses the new corner anchors.

`/tikz/corner south right=<specification>` (style, default 0pt)

The same as `/tikz/south right` but uses the new corner anchors.

`/tikz/corner west above=<specification>` (style, default 0pt)

The same as `/tikz/west above` but uses the new corner anchors.

`/tikz/corner west below=<specification>` (style, default 0pt)

The same as `/tikz/west below` but uses the new corner anchors.

`/tikz/corner east above=<specification>` (style, default 0pt)

The same as `/tikz/east above` but uses the new corner anchors.

`/tikz/corner east below=<specification>` (style, default 0pt)

The same as `/tikz/east below` but uses the new corner anchors.

While the `<specification>` of all these keys still accept the same form as with TikZ, the `ext.positioning-plus` library extends this even more.

The specification after `of` can contain a list of coordinates (like the `fit` key of the `fit` library). This means that the new node will be placed in relation to a rectangular bounding box that fits around all this nodes in the list.

If this list is prefixed with `|`, `-` or `+`, the new node will also have the same height (`|`), the same width (`-`) or both as this bounding box.

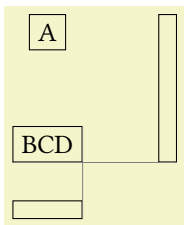

```
\usetikzlibrary {ext.positioning-plus}
\begin{tikzpicture}[nodes=draw]
\node (A) {A};
\node[below=of A] (BCD) {BCD};
\node[right=of |(A)(BCD)] (c) {};
\node[below=.5:of -(A)(BCD)] (d) {};
\draw[help lines] (BCD.south west) -- (c.south east)
(BCD.north east) -- (d.south east);
\end{tikzpicture}
```

This functionality is also available without the placement:

`/tikz/fit bounding box=<list of coordinates>` (style, no default)

Creates a rectangular node with the name `fit bounding box` that encompasses the *<list of coordinates>*.

`/tikz/span vertical=<list of coordinates>` (style, no default)

Creates a rectangular node with the name `fit bounding box` that encompasses the *<list of coordinates>* and sets the `/pgf/minimum height` to the height of this bounding box.

`/tikz/span horizontal=<list of coordinates>` (style, no default)

Creates a rectangular node with the name `fit bounding box` that encompasses the *<list of coordinates>* and sets the `/pgf/minimum width` to the width of this bounding box.

`/tikz/span=<list of coordinates>` (style, no default)

Is a combination of `/tikz/span vertical` and `/tikz/span horizontal`.

As you maybe noticed in the example above, the *<specification>* also allows a prefix delimited by `:` which the node `distance` will be multiplied to with for the placement.⁵

⁵This is probably more useful when `/tikz/on grid` is used.

13 Scaling Pictures to a Specific Size

TikZ Library `ext.scalepicture`

```
\usetikzlibrary{ext.scalepicture} % LATEX and plain TEX
\usetikzlibrary[ext.scalepicture] % ConTEXt
```

This library scales TikZ pictures to a specific width or height by scaling the whole picture.

If one of the keys below are used on a TikZ picture, i.e. as an option to `\tikzpicture` or `\begin{tikzpicture}` the size of the picture⁶ will be measured and written to the AUX file so that it will be available at the next compilation run and an appropriate scaling for the picture can be installed.

`\tikzextpicturewidth`

Returns the last measured width of the picture.

This will expand to `0pt` if the picture hasn't been measured before.

`\tikzextpictureheight`

Returns the last measured height of the picture.

This will expand to `0pt` if the picture hasn't been measured before.

`/tikz/save picture size` (style, no value)

This key is usually used by the keys provided by this library. Normally, this is not needed to be explicitly given.

13.1 Keeping the aspect ratio

The following *unstarred* keys do not change the aspect ratio of the picture.

`/tikz/picture width=<dimension>` (no default)

Scales the picture so that the width of the picture will be `<dimension>`. This will keep the aspect ratio the same.

`/tikz/minimum picture width=<dimension>` (no default)

As above but will not change the size of the picture if its width is greater than `<dimension>`.

`/tikz/maximum picture width=<dimension>` (no default)

As above but will not change the size of the picture if its width is less than `<dimension>`.

`/tikz/picture height=<dimension>` (no default)

Scales the picture so that the height of the picture will be `<dimension>`. This will keep the aspect ratio the same.

`/tikz/minimum picture height=<dimension>` (no default)

As above but will not change the size of the picture if its height is greater than `<dimension>`.

`/tikz/maximum picture height=<dimension>` (no default)

As above but will not change the size of the picture if its height is less than `<dimension>`.

`/tikz/minimum picture size={<width>}{<height>}` (no default)

Scales the picture so that its height will be at least `<width>` and its height will be at least `<height>`.

`/tikz/maximum picture size={<width>}{<height>}` (no default)

Scales the picture so that its height will be at most `<width>` and its height will be at most `<height>`.

13.2 Changing the aspect ratio.

The following *starred* keys do change the aspect ratio.

`/tikz/picture width*=<dimension>` (no default)

Scales the picture so that the width of the picture will be `<dimension>`. This will only scale the *x* axis.

⁶This is the size of the pseudo-node `current bounding box`.

`/tikz/minimum picture width*= $\langle dimension \rangle$` (no default)

As above but will not change the size of the picture if its width is greater than $\langle dimension \rangle$.

`/tikz/maximum picture width*= $\langle dimension \rangle$` (no default)

As above but will not change the size of the picture if its width is less than $\langle dimension \rangle$.

`/tikz/picture height*= $\langle dimension \rangle$` (no default)

Scales the picture so that the height of the picture will be $\langle dimension \rangle$. This will only scale the y axis.

`/tikz/picture size*={ $\langle width \rangle$ }{ $\langle height \rangle$ }` (no default)

Scales the picture so that its width will be $\langle width \rangle$ and its height will be $\langle height \rangle$. This will scale both axes but independent from each other.

14 Arcs through Three Points

TikZ Library `ext.topaths.arcthrough`

```
\usetikzlibrary{ext.topaths.arcthrough} % LATEX and plain TEX
\usetikzlibrary[ext.topaths.arcthrough] % ConTEXt
```

This library allows to use an arc defined by three points.

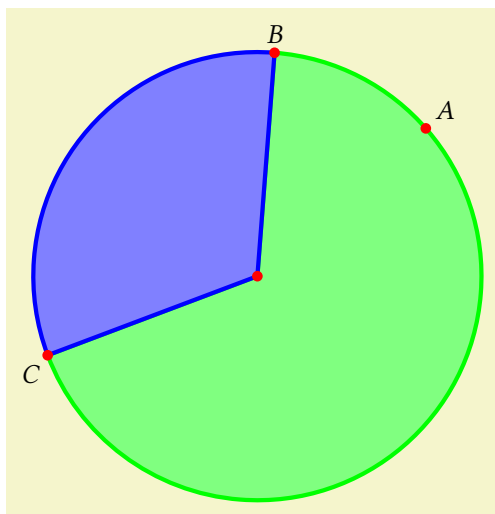

```
\usetikzlibrary {ext.topaths.arcthrough}
\begin{tikzpicture}
\coordinate[label=above right:$A$] (A) at ( 3, 1);
\coordinate[label=above:$B$] (B) at ( 1, 2);
\coordinate[label=below left:$C$] (C) at (-2,-2);

\draw[ultra thick, draw=green, fill=green!50]
(B) to[arc through={clockwise, (A)}] (C)
-- (arc through center) -- cycle;
\draw[ultra thick, draw=blue, fill=blue!50]
(B) to[arc through=(A)] (C)
-- (arc through center) -- cycle;

\foreach \p in {A,B,C, arc through center} \fill[red] (\p) circle[radius=2pt];
\end{tikzpicture}
```

This can only be used for circles in the canvas coordinate system.

`/tikz/arc through/through=<coordinate>` (no default, initially (0,0))

The coordinate on the circle that defines – together with the starting and target point – a circle.

`/tikz/arc through/center suffix=<suffix>` (no default, initially)

The arc through will define a coordinate named `arc through center<suffix>` so that it can be referenced later.

`/tikz/arc through/clockwise` (no value)

The resulting arc will go clockwise from the starting point to the target point.

This will not necessarily go through the through point.

`/tikz/arc through/counter clockwise` (no value)

The resulting arc will go counter clockwise from the starting point to the target point. This will not necessarily go through the through point.

`/tikz/arc through=<key-value>` (no default)

This key should be used with `to` or `edge`. A parameter other than `center suffix`, `clockwise` or `counter clockwise` will be assumed to be the through coordinate.

15 Mirror, Mirror on the Wall

TikZ Library `ext.transformations.mirror`

```
\usetikzlibrary{ext.transformations.mirror} % LATEX and plain TEX
\usetikzlibrary[ext.transformations.mirror] % ConTEXt
```

This library adds more transformations to TikZ.

As explained in section 17, there are two approaches to setting a mirror transformation. As with the commands in PGF, we'll be using a lowercase `m` for the reflection matrix and an uppercase `M` for the built-in approach.

15.1 Using the reflection matrix

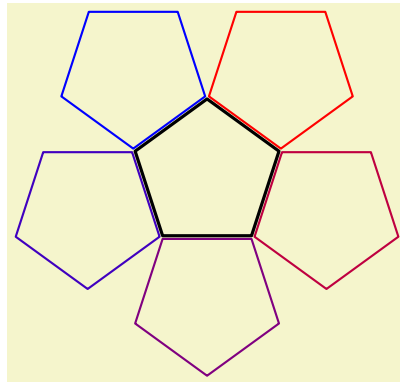

```
\usetikzlibrary {shapes.geometric,ext.transformations.mirror}
\begin{tikzpicture}[line join=round, thick, reg poly/.style={
  shape=regular polygon, regular polygon sides=#1}]
\node[reg poly=5, minimum size=+2cm, draw, very thick] (a) {};
\foreach \i[evaluate={\col=(\i-1)/.04}] in {1,...,5}
  \node [mirror=(a.corner \i)--(a.side \i), transform shape,
    reg poly=5, minimum size=+2cm, draw=red!\col!blue] {};
\end{tikzpicture}
```

`/tikz/xmirror=<value or coordinate>`

(default 0pt)

Sets up a transformation that mirrors along a horizontal line that goes through point (`<value>`, 0) or `<coordinate>`.

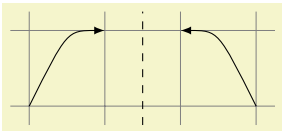

```
\usetikzlibrary {ext.transformations.mirror}
\begin{tikzpicture}
\draw[help lines] (-0.25, -.25) grid (3.25, 1.25);
\draw[-latex] (0,0) .. controls (.5,1) .. (1,1);
\draw[dashed] (1.5, -.25) coordinate (m) -- (1.5, 1.25);
\draw[xmirror=(m),-latex] (0,0) .. controls (.5,1) .. (1,1);
\end{tikzpicture}
```

`/tikz/ymirror=<value or coordinate>` (default 0pt)

Sets up a transformation that mirrors along a vertical line that goes through point $(0, \langle value \rangle)$ or $\langle coordinate \rangle$.

`/tikz/mirror x=<coordinate>` (default (0,0))

Similar to `/tikz/xmirror`, this however uses the xyz coordinate system instead of the canvas system.

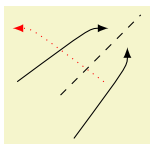

```
\usetikzlibrary {ext.transformations.mirror}
\begin{tikzpicture}[x=.5cm, y=(45:1cm)]

\draw[-latex] (0,0) .. controls (.5,1) .. (1,1);

\draw[dashed] (1.5, -.25) coordinate (m) -- (1.5, 1.25);

\draw[ xmirror=(m), -latex, red, dotted] (0,0) .. controls (.5,1) .. (1,1);
\draw[mirror x=(m), -latex] (0,0) .. controls (.5,1) .. (1,1);
\end{tikzpicture}
```

`/tikz/mirror y=<coordinate>` (default (0,0))

Similar to `/tikz/ymirror`, this however uses the xyz coordinate system instead of the canvas system.

`/tikz/mirror=<point A>--<point B>` (no default)

Sets up a transformation that mirrors along a line that goes through $\langle point A \rangle$ and $\langle point B \rangle$.

When only $\langle point A \rangle$ is given that line goes through $\langle point A \rangle$ and the origin.

15.2 Using built-in transformations

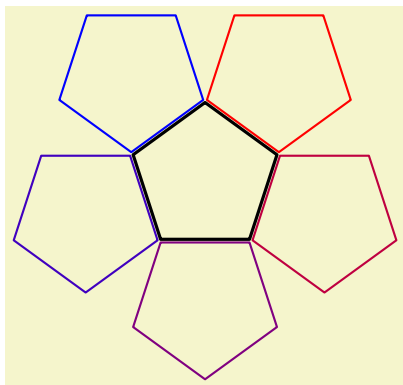

```
\usetikzlibrary {shapes.geometric,ext.transformations.mirror}
\begin{tikzpicture}[line join=round, thick, reg poly/.style={
  shape=regular polygon, regular polygon sides=#1}]
\node[reg poly=5, minimum size=+2cm, draw, very thick] (a) {};
\foreach \i[evaluate={\col=(\i-1)/.04}] in {1,...,5}
  \node [Mirror=(a.corner \i)--(a.side \i), transform shape,
    reg poly=5, minimum size=+2cm, draw=red!\col!blue] {};
\end{tikzpicture}
```

`/tikz/xMirror=<value or coordinate>`

(default 0pt)

Sets up a transformation that mirrors along a horizontal line that goes through point ($\langle value \rangle, 0$) or $\langle coordinate \rangle$.

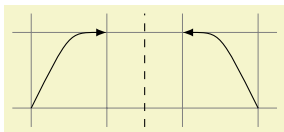

```
\usetikzlibrary {ext.transformations.mirror}
\begin{tikzpicture}
\draw[help lines] (-0.25, -0.25) grid (3.25, 1.25);
\draw[-latex] (0,0) .. controls (.5,1) .. (1,1);
\draw[dashed] (1.5, -0.25) coordinate (m) -- (1.5, 1.25);
\draw[xMirror=(m),-latex] (0,0) .. controls (.5,1) .. (1,1);
\end{tikzpicture}
```

`/tikz/yMirror=<value or coordinate>`

(default 0pt)

Sets up a transformation that mirrors along a vertical line that goes through point $(0, \langle value \rangle)$ or $\langle coordinate \rangle$.

`/tikz/Mirror x=<coordinate>`

(default (0,0))

Similar to `/tikz/xMirror`, this however uses the xyz coordinate system instead of the canvas system.

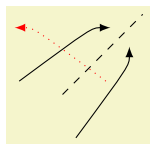

```
\usetikzlibrary {ext.transformations.mirror}
\begin{tikzpicture}[x=.5cm, y=(45:1cm)]
\draw[-latex] (0,0) .. controls (.5,1) .. (1,1);
\draw[dashed] (1.5, -0.25) coordinate (m) -- (1.5, 1.25);
\draw[xMirror=(m), -latex, red, dotted] (0,0) .. controls (.5,1) .. (1,1);
\draw[Mirror x=(m), -latex] (0,0) .. controls (.5,1) .. (1,1);
\end{tikzpicture}
```

`/tikz/Mirror y=<coordinate>`

(default (0,0))

Similar to `/tikz/yMirror`, this however uses the xyz coordinate system instead of the canvas system.

`/tikz/Mirror=<point A>-<point B>`

(no default)

Sets up a transformation that mirrors along a line that goes through $\langle point A \rangle$ and $\langle point B \rangle$.

When only $\langle point A \rangle$ is given that line goes through $\langle point A \rangle$ and the origin.

Part III

PGF Libraries

These libraries (should) work with both PGF and TikZ.

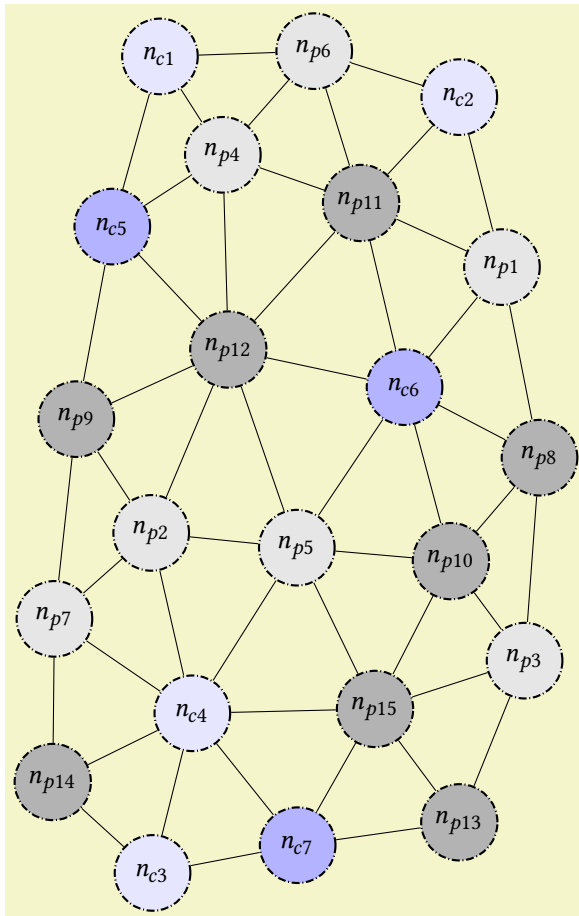

```

\usetikzlibrary {graphs,graphdrawing,ext.misc} \usegdlibrary {force}
\tikzset{
  mynode/.style={
    circle, minimum size=10mm, draw, densely dashdotted, thick,
    decide color/.expand once=#1,
    decide color/.style 2 args={
      /utils/TeX/if=c#1
      {/utils/TeX/ifnum=#2<5}{blue!light}{blue!dark}}
      {/utils/TeX/ifnum=#2<8}{light}{dark}}},
  light/.style={fill=gray!20}, blue!light/.style={fill=blue!10},
  dark/.style={fill=gray!60}, blue!dark/.style={fill=blue!30}}
\tikz\graph[
  spring electrical layout, vertical=c2 to p13,
  node distance=1.5cm, typeset=$n_{\tikzgraphnodetext}$,
  nodes={mynode=\tikzgraphnodetext}] {
  % outer ring
  c2 -- {p1, p11, p6};
  p1 -- {p8, c6, p11};
  p8 -- {p3, p10, c6};
  p3 -- {p13, p15, p10};
  p13 -- {p15, c7};
  c7 -- {c3, c4, p15};
  c3 -- {p14, c4};
  p14 -- {p7, c4};
  p7 -- {p9, p2, c4};
  p9 -- {c5, p12, p2};
  c5 -- {c1, p4, p12};
  c1 -- {p6, p4};
  p6 -- {p11, p4};
  % inner ring
  p11 -- {c6, p12, p4};
  p5 -- {c6 -- {p10, p12}, p10 -- p15, p15 -- c4, c4 -- p2, p2 -- p12, p12 -- p4};
};

```

16 Arrow Tips

TikZ Library `ext.arrows`

```
\usepgflibrary{ext.arrows} % LATEX and plain TEX and pure pgf
\usepgflibrary[ext.arrows] % ConTEXt and pure pgf
\usetikzlibrary{ext.arrows} % LATEX and plain TEX when using TikZ
\usetikzlibrary[ext.arrows] % ConTEXt when using TikZ
```

This library adds arrows to PGF/TikZ.

Q & A: [14, 8, 3, 12] & [40, 28, 45, 38]

The arrow tips of the `arrows.meta` library always just touch the end of original line – which is usually what you want.

But for some arrow tips (and when they lie along a path) it makes sense that these tips shoot a bit over the end of the line. This is why these arrow tips exist. They can be categorized into three groups:

1. Centered
2. Untipped
3. Overtipped⁷

Not all original arrow tips got all variants. For a summary, refer to table on the right side. As with the original tips of the `arrows.meta` library these can be organized in the following categories.

Group	Original	Centered	Untipped	Overtipped
Barbed	Arc Barb			-
	Parenthesis			-
	Hooks		-	-
	Straight Barb		-	-
	Tee Barb			-
	Bar			-
	Bracket			-
Geometric	Circle			-
	Ellipse			-
	Kite		-	-
	Diamond		-	-
	Turned Square		-	-
	LaTeX	-	-	-
	Square		-	-
	Rectangle		-	-
	Stealth		-	-
	Triangle		-	-
Rays	Rays		-	-

⁷The Overtipped arrow tips aren't yet implemented.

16.1 Centered

16.1.1 Barbed Arrow Tips

Arrow Tip Kind Centered Arc Barb

This is a variant of the Arc Barb tip. The center of the arc lies on the original end of the path.

Arrow Tip Kind Centered Bar

A variant of the simple Bar tip. This is a simple instance of Centered Tee Barb for length zero.

The middle of the line will lie on original end of the path.

Arrow Tip Kind Centered Bracket

This is a variant of the Bracket tip and therefore an instance of the Centered Tee Barb arrow tip that results in something resembling a bracket.

The middle of the vertical part will lie on the original end of the path.

Arrow Tip Kind Centered Hooks

A variant of the Hooks tip. The starting point of the hooks will lie on the original end of the path.

Arrow Tip Kind Centered Parenthesis

This is a variant of the Parenthesis tip and thus an instance of the Centered Arc Barb arrow tip.

Arrow Tip Kind Centered Straight Barb

A variant of the Straight Barb tip.

Arrow Tip Kind Centered Tee Barb

A variant of the Tee Barb tip.

The middle of the vertical part will lie on the original end of the path.

16.1.2 Geometric Arrow Tips

Arrow Tip Kind Centered Circle

A variant of the Circle tip. The center of the circle will lie on the original end of the path.

Arrow Tip Kind Centered Diamond

This is a variant of the Diamond tip and thus an instance of Centered Kite where the length is larger than the width.

Arrow Tip Kind Centered Ellipse

This is a variant of the Ellipse tip and thus another name for the Centered Circle tip that is twice as wide as high.

Arrow Tip Kind Centered Kite

A variant of the Kite tip.

The widest part will lie on the original end of the path.

Arrow Tip Kind Centered Rectangle

A variant of the Rectangle tip. By default, it is twice as long as high.

Arrow Tip Kind Centered Square

A variant of the Square tip.

Arrow Tip Kind Centered Stealth

This is a variant of the Stealth tip.

The weighted center will lie at the original end of the path.

Arrow Tip Kind Centered Triangle

This is a variant of the Triangle tip and thus an instance of the Centered Kite tip with zero inset.

Arrow Tip Kind Centered Turned Square

This is a variant of the Turned Square tip and thus an instance of the Centered Kite tip with identical width and height and mid-inset.

16.1.3 Special Arrow Tips

Arrow Tip Kind Centered Rays

A variant of the Rays tip. The origin of the rays will lie on the original end of the path.

16.2 Untipped

16.2.1 Barbed Arrow Tips

Arrow Tip Kind Centered Arc Barb

This is a variant of the Arc Barb tip. The arrow tip will protrude half its line width over the original end of the path.

Arrow Tip Kind Untipped Bar

A variant of the simple Bar tip. This is a simple instance of Untipped Tee Barb for length zero.

The middle of the line will lie on original end of the path.

Arrow Tip Kind Untipped Bracket

This is a variant of the Bracket tip and therefore an instance of the Untipped Tee Barb arrow tip that results in something resembling a bracket.

The arrow tip will protrude half its line width over the original end of the path.

Arrow Tip Kind Untipped Parenthesis

This is a variant of the Parenthesis tip and thus an instance of the Untipped Arc Barb arrow tip.

Arrow Tip Kind Untipped Tee Barb

A variant of the Tee Barb tip.

The middle of the vertical part will lie on the original end of the path.

16.2.2 Geometric Arrow Tips

Arrow Tip Kind Untipped Circle

A variant of the Circle tip. This tip will protrude half its line width over the original end of the path.

Arrow Tip Kind Untipped Ellipse

This is a variant of the Ellipse tip and thus another name for the Untipped Circle tip that is twice as wide as high.

16.3 Original Arrow Tips

Arrow Tip Kind Hug Cap

This arrow tip will hug a circle that would touch the end of the path.

Use the `/pgf/arrow keys/length` key to set up the radius of that circle.

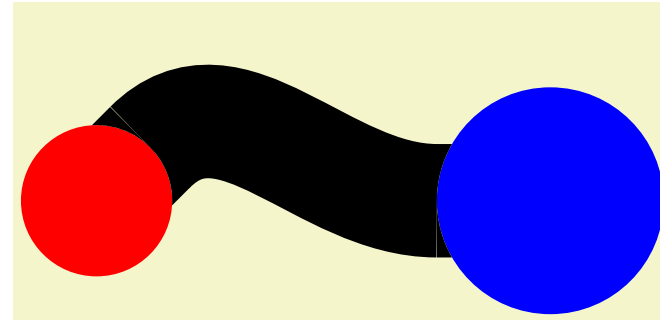

```
\usepgflibrary {ext.arrows}
\begin{tikzpicture}[
  dot/.style 2 args={
    shape=circle, outer sep=+0pt, fill={#1}, minimum size={#2}}]
\node[dot={red} {2cm}] (A) {};
\node[dot={blue}{3cm}] (B) at (6,0) {};
\draw[
  line width=1.5cm,
  arrows={Hug Cap[length=1cm]-Hug Cap[length=1.5cm]}
] (A) to[out=45, in=180] (B);
\end{tikzpicture}
```

Arrow Tip Kind Loop

This arrow tip attaches a one-sided loop to the end of the line. The length refers to the length of the whole tip while the radius specifies the radius of the three rounded corners. The width of the tip is twice the length (but can't specified independently).

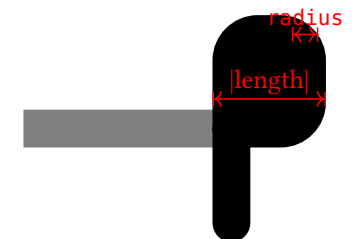

Appearance of the below at line width

Loop[]

Loop[sep] Loop[]

0.4pt

—● thin

—●● thin

0.8pt

—● thick

—●● thick

1.6pt

—●●●

`Loop[sep] . Loop[]`
`Loop[open]`
`Loop[open, swap]`
`Loop[length=5pt, radius=0pt]`
`Loop[reversed]`

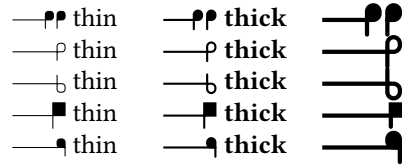

`Loop[slant=.3]`
`Loop[red]`

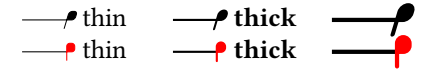

The following options have no effect: harpoon, round, line width.
 On double lines, the arrow tip will not look correct.

17 Transformations: Mirroring

PGF Library `ext.transformations.mirror`

```
\usepgflibrary{ext.transformations.mirror} % LATEX and plain TEX
\usepgflibrary[ext.transformations.mirror] % ConTEXt
```

This library adds mirror transformations to PGF.

Two approaches to mirror transformation exist:

1. Using the reflection matrix (see left column).

This depends on `\pgfpointnormalised` which involves the sine and the cosine functions of PGFmath.

2. Using built-in transformations (see right column).

This depends on `\pgfmathanglebetweenpoints` which involves the arctangent (`atan2`) function of PGFmath.

Which one is better? I don't know. Choose one you're comfortable with.

17.1 Using the reflection matrix

The following commands use the reflection matrix that sets the transformation matrix following

$$A = \frac{1}{\|\vec{l}\|^2} \begin{bmatrix} l_x^2 - l_y^2 & 2l_x l_y \\ 2l_x l_y & l_y^2 - l_x^2 \end{bmatrix}.$$

`\pgftransformxmirror{⟨value⟩}`

Sets up a transformation that mirrors along a vertical line that goes through point $(⟨value⟩, 0)$.

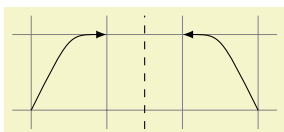

```
\usepgflibrary {transformations.mirror}
\begin{tikzpicture}
\draw[help lines] (-.25, -.25) grid (3.25, 1.25);
\draw[-latex] (0,0) .. controls (.5,1) .. (1,1);
\draw[dashed] (1.5, -.25) -- (1.5, 1.25);
\pgftransformxmirror{1.5}
\draw[-latex] (0,0) .. controls (.5,1) .. (1,1);
\end{tikzpicture}
```

17.2 Using built-in transformations

The following commands use a combination of shifting, rotating, -1 scaling, rotating back and shifting back to reach the mirror transformation.

The commands are named the same as on the left side, only the `m` in `mirror` is capitalized.

`\pgftransformxMirror{⟨value⟩}`

Sets up a transformation that mirrors along a vertical line that goes through point $(⟨value⟩, 0)$.

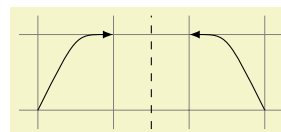

```
\usepgflibrary {transformations.mirror}
\begin{tikzpicture}
\draw[help lines] (-.25, -.25) grid (3.25, 1.25);
\draw[-latex] (0,0) .. controls (.5,1) .. (1,1);
\draw[dashed] (1.5, -.25) -- (1.5, 1.25);
\pgftransformxMirror{1.5}
\draw[-latex] (0,0) .. controls (.5,1) .. (1,1);
\end{tikzpicture}
```

`\pgftransformymirror{⟨value⟩}`

Sets up a transformation that mirrors along a horizontal line that goes through point $(0, \langle value \rangle)$.

`\pgftransformmirror{⟨point A⟩}{⟨point B⟩}`

Sets up a transformation that mirrors along the line that goes through $\langle point A \rangle$ and $\langle point B \rangle$.

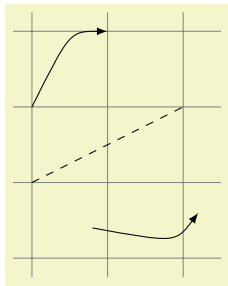

```
\usepgflibrary {transformations.mirror}
\begin{tikzpicture}
\draw[help lines] (-.25, -.25) grid (2.5, 1.25);
\draw[-latex] (0,0) .. controls (.5,1) .. (1,1);

\draw[dashed] (0, -1) -- (2, 0);
\pgftransformmirror{\pgfpointxy{0}{-1}}
{\pgfpointxy{2}{ 0}}

\draw[-latex] (0,0) .. controls (.5,1) .. (1,1);
\end{tikzpicture}
```

`\pgftransformyMirror{⟨value⟩}`

Sets up a transformation that mirrors along a horizontal line that goes through point $(0, \langle value \rangle)$.

`\pgftransformMirror{⟨point A⟩}{⟨point B⟩}`

Sets up a transformation that mirrors along the line that goes through $\langle point A \rangle$ and $\langle point B \rangle$.

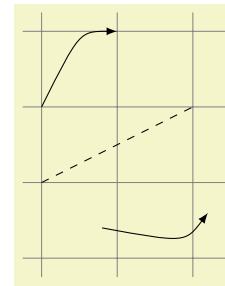

```
\usepgflibrary {transformations.mirror}
\begin{tikzpicture}
\draw[help lines] (-.25, -.25) grid (2.5, 1.25);
\draw[-latex] (0,0) .. controls (.5,1) .. (1,1);

\draw[dashed] (0, -1) -- (2, 0);
\pgftransformMirror{\pgfpointxy{0}{-1}}
{\pgfpointxy{2}{ 0}}

\draw[-latex] (0,0) .. controls (.5,1) .. (1,1);
\end{tikzpicture}
```

`\pgfqtransformmirror{⟨point A⟩}`

Sets up a transformation that mirrors along the line that goes through the origin and $\langle point A \rangle$.

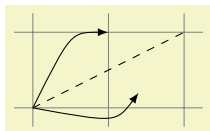

```
\usepgflibrary {transformations.mirror}
\begin{tikzpicture}
\draw[help lines] (-.25, -.25) grid (2.25, 1.25);
\draw[-latex] (0,0) .. controls (.5,1) .. (1,1);

\draw[dashed] (0, 0) -- (2, 1);
\pgfqtransformmirror{\pgfpointxy{2}{1}}

\draw[-latex] (0,0) .. controls (.5,1) .. (1,1);
\end{tikzpicture}
```

`\pgfqtransformMirror{⟨point A⟩}`

Sets up a transformation that mirrors along the line that goes through the origin and $\langle point A \rangle$.

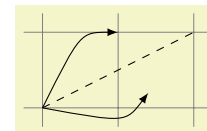

```
\usepgflibrary {transformations.mirror}
\begin{tikzpicture}
\draw[help lines] (-.25, -.25) grid (2.25, 1.25);
\draw[-latex] (0,0) .. controls (.5,1) .. (1,1);

\draw[dashed] (0, 0) -- (2, 1);
\pgfqtransformMirror{\pgfpointxy{2}{1}}

\draw[-latex] (0,0) .. controls (.5,1) .. (1,1);
\end{tikzpicture}
```

18 Shape: Circle Arrow

TikZ Library `ext.shapes.circulararrow`

```
\usepgflibrary{ext.shapes.circulararrow} % LATEX and plain TEX and pure pgf
\usepgflibrary[ext.shapes.circulararrow] % ConTEXt and pure pgf
\usetikzlibrary{ext.shapes.circulararrow} % LATEX and plain TEX when using TikZ
\usetikzlibrary[ext.shapes.circulararrow] % ConTEXt when using TikZ
```

A circular shape named `circle arrow` that has an arc as its background path that can have an arrow tip.

Q & A: [24] & [42]

Shape `circle arrow`

This shape is an arrow whose path is an arc – defined very similar to the `arc path operation` – that can possibly be customized with arrow tips.

`/pgf/circle arrow start angle=<start angle>` (no default, initially {})
Sets the start angle.

`/pgf/circle arrow end angle=<end angle>` (no default, initially {})
Sets the end angle.

`/pgf/circle arrow delta angle=<delta angle>` (no default, initially {})
Sets the delta angle.

`/pgf/circle arrow arrows=<start arrow tip specification>-<end arrow tip specification>` (no default, initially -)
The specification will be forwarded to `\pgfsetarrows`.

A few handful styles are pre-defined.

`/pgf/circle arrow turn left north` (no value)
Sets `circle arrow start angle = 100`, `circle arrow delta angle = 340` and `circle arrow arrows = ->`.

`/pgf/circle arrow turn left east` (no value)
As above but `circle arrow start angle = 10`.

`/pgf/circle arrow turn left west` (no value)
As above but `circle arrow start angle = 280`.

`/pgf/circle arrow turn left south` (no value)
As above but `circle arrow start angle = 190`.

`/pgf/circle arrow turn right north`

Sets circle arrow start angle = 100, circle arrow delta angle = 340 and circle arrow arrows = <-.

(no value)

`/pgf/circle arrow turn right east`

As above but circle arrow start angle = 10.

(no value)

`/pgf/circle arrow turn right west`

As above but circle arrow start angle = 280.

(no value)

`/pgf/circle arrow turn right south`

As above but circle arrow start angle = 190.

(no value)

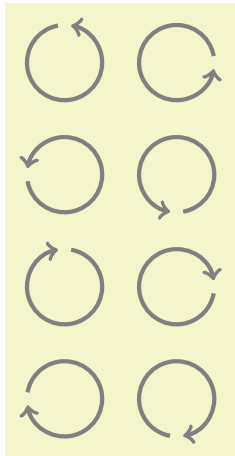

```
\usetikzlibrary {ext.shapes.circlearrow,matrix}
\begin{tikzpicture}
\matrix[matrix of nodes, draw=none, row sep=1em, column sep=1em,
every node/.style={draw=gray, shape=circle arrow, ultra thick, inner sep=1em}
] (m) {
|[circle arrow turn left north]| & |[circle arrow turn left east]| & \\
|[circle arrow turn left west]| & |[circle arrow turn left south]| & \\
|[circle arrow turn right north]| & |[circle arrow turn right east]| & \\
|[circle arrow turn right west]| & |[circle arrow turn right south]| & \\
};
\end{tikzpicture}
```

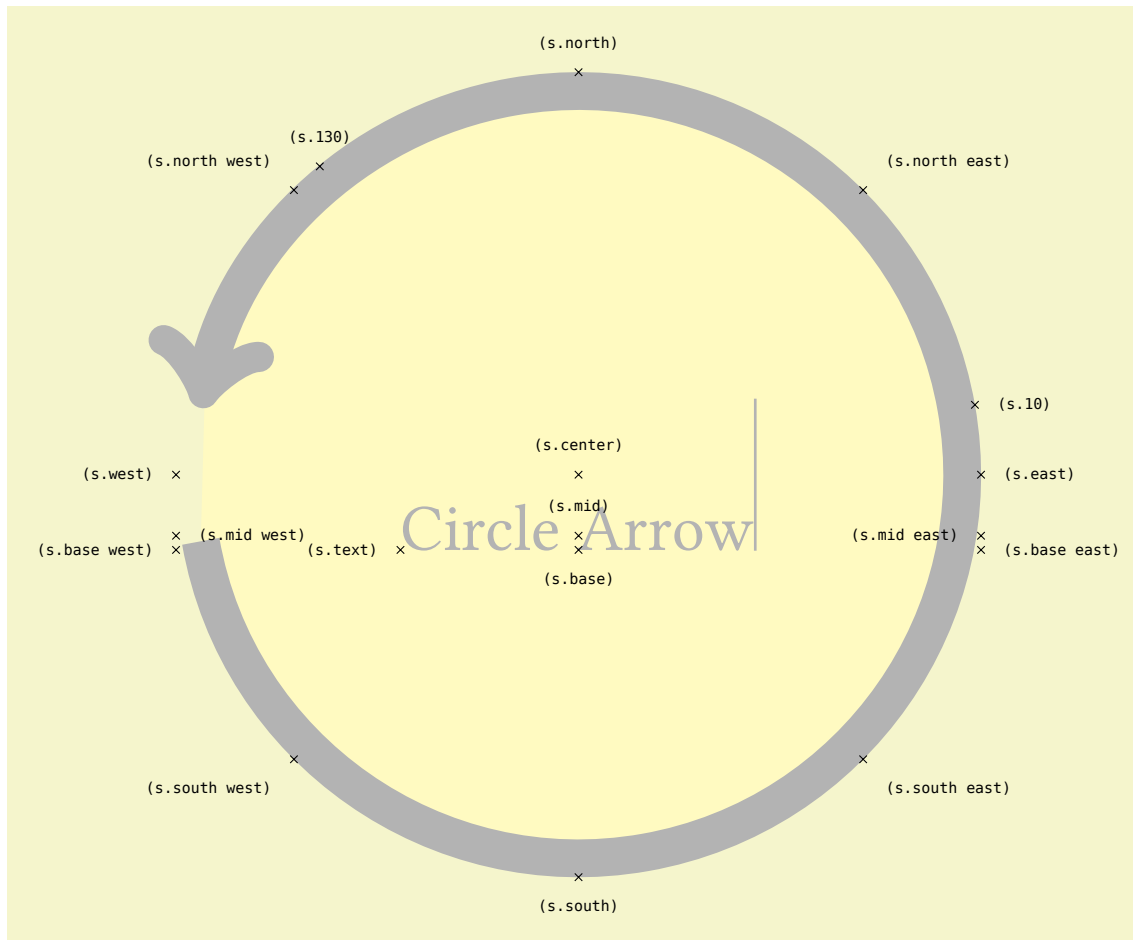

```

\usetikzlibrary {ext.shapes.circlearrow}
\begin{tikzpicture}\Huge
\node[name=s, shape=circle arrow,
circle arrow turn left west, shape example]
{Circle Arrow\vrule width 1pt height 2cm};
\foreach \anchor/\placement in
{north west/above left, north/above,
north east/above right,
west/left, center/above, east/right,
mid west/right, mid/above, mid east/left,
base west/left, base/below, base east/right,
south west/below left, south/below,
south east/below right,
text/left, 10/right, 130/above}
\draw[shift=(s.\anchor)] plot[mark=x] coordinates{(0,0)}
node[\placement] {\scriptsize\texttt{(s.\anchor)}};
\end{tikzpicture}

```

19 Shape: Circle Cross Split

TikZ Library `ext.shapes.circlecrosssplit`

```
\usepgflibrary{ext.shapes.circlecrosssplit} % LATEX and plain TEX and pure pgf
\usepgflibrary[ext.shapes.circlecrosssplit] % ConTEXt and pure pgf
\usetikzlibrary{ext.shapes.circlecrosssplit} % LATEX and plain TEX when using TikZ
\usetikzlibrary[ext.shapes.circlecrosssplit] % ConTEXt when using TikZ
```

A circular shape with four parts that can be individually filled.

Q & A: [18] & [43]

Shape `circle cross split`

This shape has four node parts that are placed near the center of a circle.

`/pgf/circle cross split part fill={list}` (no default, initially none)

Sets the custom fill color for each node part shape. The items in *list* should be separated by commas (so if there is more than one item in *list*, it must be surrounded by braces). If *list* has less entries than node parts, then the remaining node parts use the color from the last entry in the list. This key will automatically set `/pgf/circle cross split uses custom fill`.

`/pgf/circle cross split uses custom fill=boolean` (default true)

This enables the use of a custom fill for each of the node parts (including the area covered by the inner sep). The background path for the shape should not be filled (e. g., in TikZ, the `fill` option for the node must be implicitly or explicitly set to none). Internally, this key sets the T_EX-if `\ifpgfcirclecrosssplitcustomfill` appropriately.

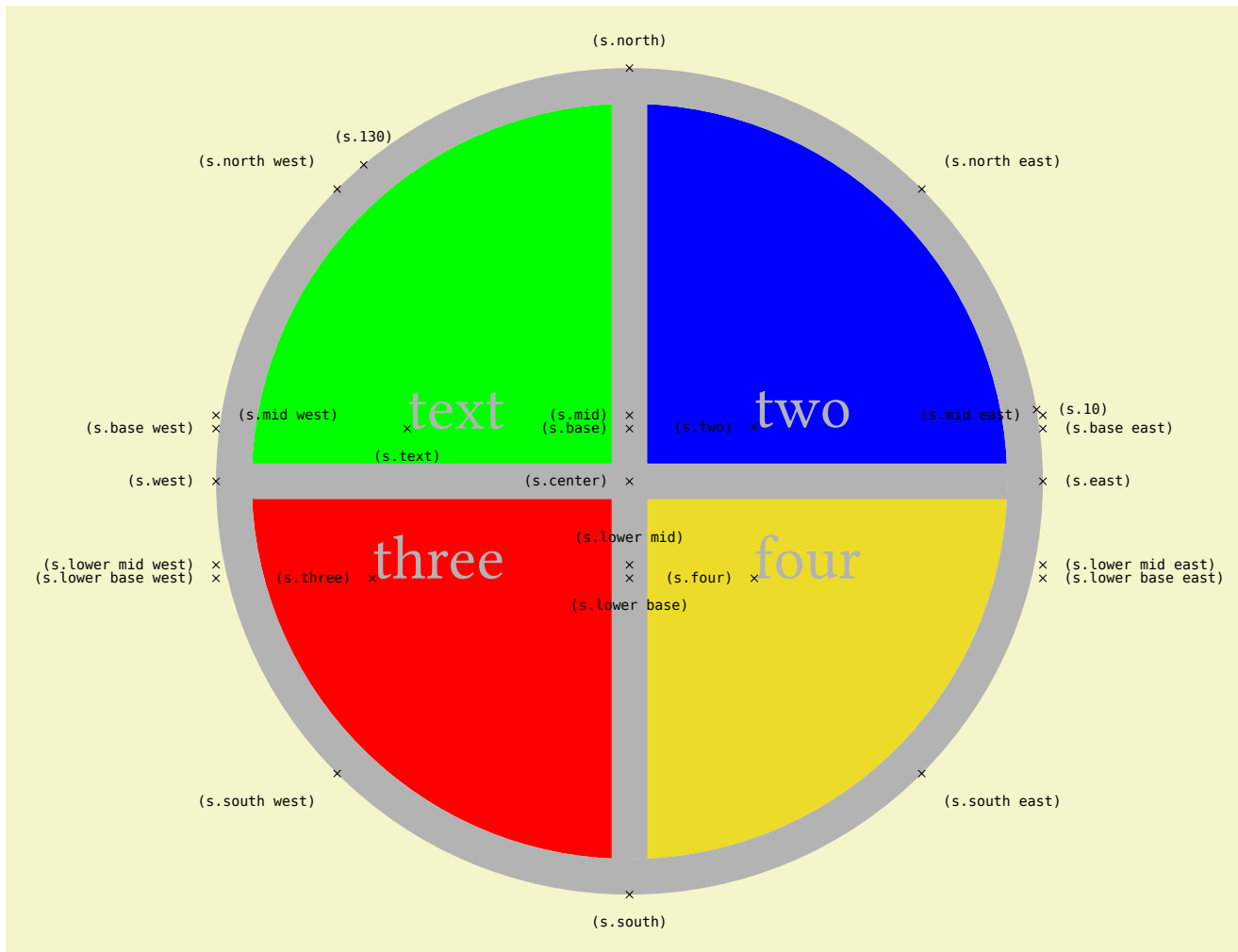

```

\usepgflibrary {ext.shapes.circlecrosssplit}
\begin{tikzpicture}\Huge
\node[name=s, shape=circle cross split, shape example, inner xsep=1.5cm, fill=none,
circle cross split part fill={green,blue,red,yellow!90!black}]
{\nodepart{text}text\nodepart{two}two
\nodepart{three}three\nodepart{four}four};
\foreach \anchor/\placement in
{north west/above left, north/above, north east/above right,
west/left, center/left, east/right,
mid west/right, mid/left, mid east/left,
base west/left, base/left, base east/right,
lower base west/left, lower base/below, lower base east/right,
lower mid west/left, lower mid/above, lower mid east/right,
south west/below left, south/below, south east/below right,
text/below, 10/right, 130/above, two/left, three/left, four/left}
\draw[shift=(s.\anchor)] plot[mark=x] coordinates{(0,0)}
node[\placement] {\scriptsize\texttt{(s.\anchor)}};
\end{tikzpicture}

```

20 Shape: Heatmark

TikZ Library `ext.shapes.heatmark`

```
\usepgflibrary{ext.shapes.heatmark} % LATEX and plain TEX and pure pgf
\usepgflibrary[ext.shapes.heatmark] % ConTEXt and pure pgf
\usetikzlibrary{ext.shapes.heatmark} % LATEX and plain TEX when using TikZ
\usetikzlibrary[ext.shapes.heatmark] % ConTEXt when using TikZ
```

A circular shape that has customizable rings around it.

Q & A: [2] & [33]

Shape `heatmark`

`/pgf/heatmark arcs=(arcs num)` (no default, initially 3)

Sets the number of arc around the circle to *(arcs num)*.

`/pgf/heatmark arc width=(arc width)` (no default, initially 4pt)

Sets the width of the rings around the circle to *(arc width)*.

`/pgf/heatmark arc sep=(sep length)` (no default, initially 1pt)

Sets the whitespace between the rings to *(sep length)*.

`/pgf/heatmark arc rings=(rings num)` (no default, initially 3)

Sets the number of rings around the circle to *(rings num)*

`/pgf/heatmark arc sep angle=(sep angle)` (no default, initially 20)

Sets the whitespace angle between the arcs in one ring to *(sep angle)*.

`/pgf/heatmark inner opacity=(inner opacity)` (no default, initially 0.8)

Sets the opacity of the inner ring to *(inner opacity)*.

`/pgf/heatmark outer opacity=(low opacity)` (no default, initially 0.2)

Sets the opacity of the outer ring to *(outer opacity)*.

The opacity of the rings between the outer and the inner ring will be interpolated by these two opacities.

This shape takes the value of `/pgf/shape border rotate` into consideration.

For every ring and for every arc the following styke keys are tried.

`/pgf/heatmark ring (ring number)` (style, no value)

`/pgf/heatmark arc <arc number>`

(style, no value)

`/pgf/heatmark ring <ring number> arc <arc number>`

(style, no value)

The `pgfshape` is setup in a way that even TikZ styles can be used with a little bit work:

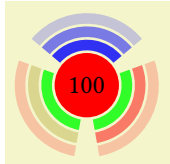

```
\usetikzlibrary {ext.shapes.heatmark}
\tikz[
  shape border rotate=90,
  /pgf/heatmark ring 1/.append style={/tikz/fill=green},
  /pgf/heatmark arc 1/.append style={/tikz/fill=blue},
  /pgf/heatmark ring 2 arc 2/.append style={/tikz/fill=yellow!70!black}
] \node[heatmark, fill=red] (n) {100};
```

It is best to use this shape with no actual border (`draw = none`) and the `outer sep` set to zero.

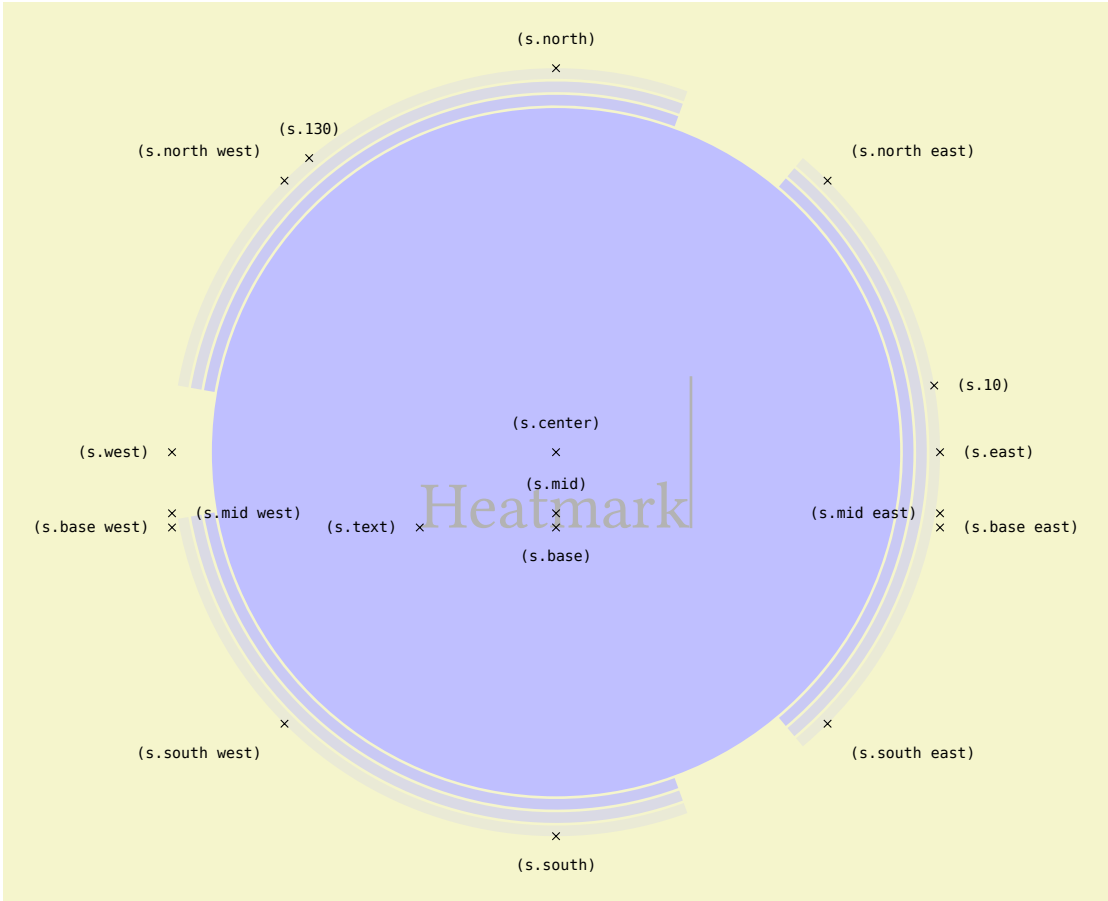

```

\usetikzlibrary {ext.shapes.heatmark}
\begin{tikzpicture}\Huge
\node[name=s, shape=heatmark, shape example,
fill=blue!25, draw=none, outer sep=0pt]
{Heatmark\vrule width 1pt height 2cm};
\foreach \anchor/\placement in
{north west/above left, north/above,
north east/above right,
west/left, center/above, east/right,
mid west/right, mid/above, mid east/left,
base west/left, base/below, base east/right,
south west/below left, south/below,
south east/below right,
text/left, 10/right, 130/above}
\draw[shift=(s.\anchor)] plot[mark=x] coordinates{(0,0)}
node[\placement] {\scriptsize\texttt{(s.\anchor)}};
\end{tikzpicture}

```

21 Shape: Rectangle with Rounded Corners

TikZ Library `ext.shapes.rectangleroundedcorners`

```
\usepgflibrary{ext.shapes.rectangleroundedcorners} % LATEX and plain TEX and pure pgf
\usepgflibrary[ext.shapes.rectangleroundedcorners] % ConTEXt and pure pgf
\usetikzlibrary{ext.shapes.rectangleroundedcorners} % LATEX and plain TEX when using TikZ
\usetikzlibrary[ext.shapes.rectangleroundedcorners] % ConTEXt when using TikZ
```

A rectangle with rounded corners.

Shape `rectangle with rounded corners`

This library provides a rectangle with rounded corners where every corner can have a different radius.

<code>/pgf/rectangle with rounded corners north west radius=<dimen></code>	(no default, initially <code>.5\pgflinewidth</code>)
Sets the north west radius to <code><dimen></code> .	
<code>/pgf/rectangle with rounded corners north east radius=<dimen></code>	(no default, initially <code>.5\pgflinewidth</code>)
Sets the north east radius to <code><dimen></code> .	
<code>/pgf/rectangle with rounded corners south west radius=<dimen></code>	(no default, initially <code>.5\pgflinewidth</code>)
Sets the south west radius to <code><dimen></code> .	
<code>/pgf/rectangle with rounded corners south east radius=<dimen></code>	(no default, initially <code>.5\pgflinewidth</code>)
Sets the south east radius to <code><dimen></code> .	
<code>/pgf/rectangle with rounded corners radius=<dimen></code>	(no default)
Sets all radii to <code><dimen></code> .	

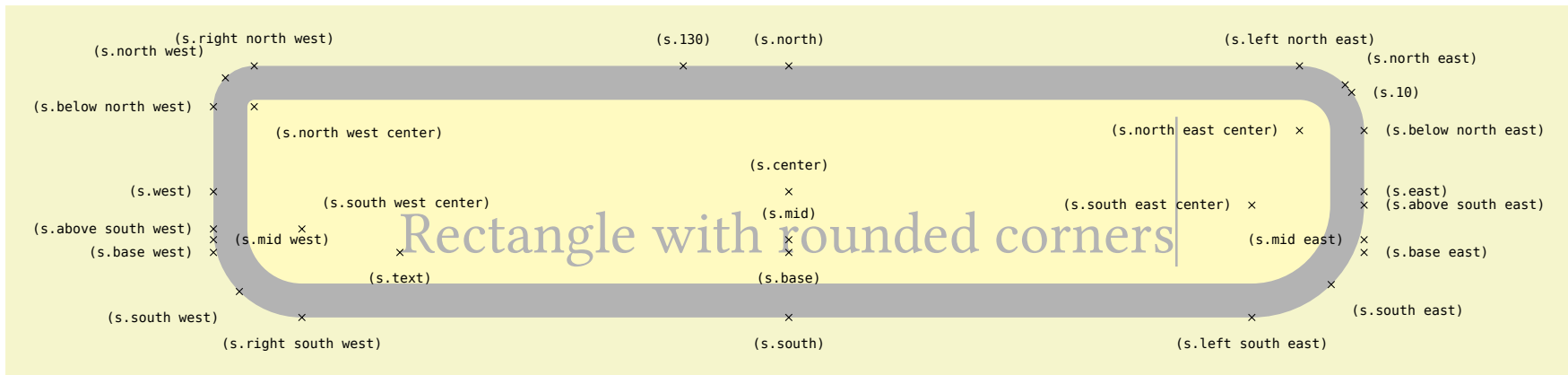

```

\usepgflibrary {ext.shapes.rectangleroundedcorners}
\begin{tikzpicture}\Huge
\node[name=s, shape=rectangle with rounded corners, shape example,
rectangle with rounded corners north west radius=10pt,
rectangle with rounded corners north east radius=20pt,
rectangle with rounded corners south west radius=30pt,
rectangle with rounded corners south east radius=40pt] {Rectangle with rounded corners\vrule width 1pt height 2cm};
\foreach \anchor/\placement in
{north west/above left, north/above, north east/above right,
west/left, center/above, east/right,
mid west/right, mid/above, mid east/left,
base west/left, base/below, base east/right,
south west/below left, south/below, south east/below right,
text/below, 10/right, 130/above,
north west center/below right, north east center/left,
south west center/above right, south east center/left,
below north west/left, above south west/left, above south east/right, below north east/right,
right north west/above, right south west/below, left south east/below, left north east/above}
\draw[shift=(s.\anchor)] plot[mark=x] coordinates{(0,0)}
node[\placement] {\scriptsize\texttt{(s.\anchor)}};
\end{tikzpicture}

```

22 Shape: Superellipse

TikZ Library `ext.shapes.superellipse`

```
\usepgflibrary{ext.shapes.superellipse} % LATEX and plain TEX and pure pgf
\usepgflibrary[ext.shapes.superellipse] % ConTEXt and pure pgf
\usetikzlibrary{ext.shapes.superellipse} % LATEX and plain TEX when using TikZ
\usetikzlibrary[ext.shapes.superellipse] % ConTEXt when using TikZ
```

Shape in the form of a “superellipse”.

Q & A: [49] & [27]

Shape `superellipse`

This shape is defined by formula

$$\left|\frac{x}{r_x}\right|^m + \left|\frac{y}{r_y}\right|^n = 1$$

and will be plotted by

$$x(t) = |\cos t|^{\frac{2}{m}} \cdot r_x \operatorname{sgn}(\cos t)$$
$$y(t) = |\sin t|^{\frac{2}{n}} \cdot r_y \operatorname{sgn}(\sin t)$$

where r_x is half the node’s width and r_y is half the node’s height.

```
/pgf/superellipse x exponent=<x exponent>
```

(no default, initially 2.5)

This sets m .

```
/pgf/superellipse y exponent=<y exponent>
```

(no default, initially 2.5)

This sets n .

```
/pgf/superellipse step=<step>
```

(no default, initially 5)

This specifies the step of the underlying plot handler. The smaller $\langle step \rangle$ is, the slower computation will be.

Sensible values for $\langle step \rangle$ are integer dividers of 90, i. e. 2, 3, 5, 6, 9, 10, 15, 18, 30 and 45.

```
/pgf/superellipse exponent=<exponent>
```

(no default)

Sets both `superellipse x exponent` and `superellipse y exponent` to $\langle exponent \rangle$.

Notes on Implementation For implementing this shape, additional mathematical functions were declared.

`superellipsex(t, 2/m, rx)`
`\pgfmathsuperellipsex{t}{2/m}{rx}`

Returns the *x* value on a point of the superellipse with its center on the origin following

$$x = r_x \cos^{2/m} t$$

for values of $0 \leq t \leq 90$.

`superellipsey(t, 2/n, ry)`
`\pgfmathsuperellipsey{t}{2/n}{ry}`

Returns the *y* value on a point of the superellipse with its center on the origin following

$$y = r_y \cos^{2/n} t$$

for values of $0 \leq t \leq 90$.

Both `\pgfmath` functions can be used at once with the following macro.

`\pgfmathsuperellipseXY{t}{2/m}{2/n}{a}{b}`

Returns the *x* value (in `\pgfmathresultX`) and the *y* value (in `\pgfmathresultY`) of the superellipse with its center on the origin following

$$x = a \cos^{2/m} t$$

$$y = b \cos^{2/n} t$$

for values of $0 \leq t \leq 90$.

Note: all arguments must be a valid number since they will not be parsed by `\pgfmath`.

And additional internal macro was defined following the original naming scheme.

`\pgfutil@prefix@macro@macro{macro 1}{macro 2}`

Adds the once-expansion of `<macro 2>` in front of `<macro 1>`.

23 Shape: Uncentered Rectangle

PGF Library `ext.shapes.uncenteredrectangle`

```
\usepgflibrary{ext.shapes.uncenteredrectangle} % LATEX and plain TEX  
\usepgflibrary[ext.shapes.uncenteredrectangle] % ConTEXt
```

A rectangle that has a variable horizontal center with three node parts.

Q & A: [52, 23] & [34, 31]

Shape `uncentered rectangle`

For some alignment problems, this shape could be useful.

It has three node parts: the standard `text` part, the `left` part that is to the left of `text` and the `right` part that is to the right of `text`.

When edges are to be connected with this shape, the following key changes to which inner center this shape will calculate the appropriate point on the border.

```
/pgf/uncentered rectangle center=<left> or <text> or <right> or <real> (no default, initially text)
```

Sets the center that is to be used for connecting edges.

This will also move the anchors `north`, `mid`, `base` and `south` along. In the picture below, this are marked red.

```
/pgf/uncentered rectangle use saved center=<true> or <false> (default true)
```

When this is set to `true`, the border anchors will use the horizontal center that was used when the node was created.

For support of the `cd` library of the `tikz-cd` package, this shape also supports a dynamic `y` value for its anchors `center`, `west` and `east`.

```
/pgf/uncentered rectangle center yshift=<dimension> (no default, initially {})
```

This determines the distance between the baseline and the center anchors.

If `<dimension>` is empty, the real vertical center will be used.

For use with `cd`, set this to `axis_height`.

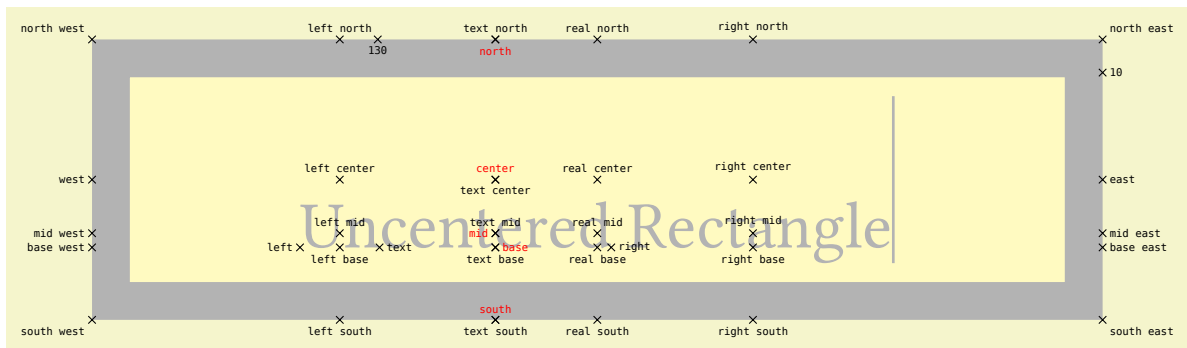

```
\usepgflibrary {ext.shapes.uncenteredrectangle}
\begin{tikzpicture}[style north/.style=red, style south/.style=red, style center/.style=red, style base/.style=red, style mid/.style=red]
\Huge
\node[shape example, name=n, uncentered rectangle]
{centered \nodepart{left} Un \nodepart{right} \space Rectangle\vrule width 1pt height 2cm}
foreach \anchor/\pos in {
north west/above left, north/below, north east/above right, real north/above, left north/above, right north/above, text north/above,
west/left, center/above, east/right, real center/above, left center/above, right center/above, text center/below,
mid west/left, mid/left, mid east/right, real mid/above, left mid/above, right mid/above, text mid/above,
base west/left, base/right, base east/right, real base/below, left base/below, right base/below, text base/below,
south west/below left, south/above, south east/below right, real south/below, left south/below, right south/below, text south/below,
10/right, 130/below, left/left, right/right, text/right}{
plot[mark=x, only marks] coordinates {(n.\anchor)}
node[inner sep=.1em, style \anchor/.try, style/.expand once=\pos] {\tiny\ttfamily\anchor}};
\end{tikzpicture}
```

TikZ Library `ext.shapes.uncenteredrectangle`

```
\usetikzlibrary{ext.shapes.uncenteredrectangle} % LATEX and plain TEX
\usetikzlibrary[ext.shapes.uncenteredrectangle] % ConTEXt
```

This library extends the `cd` library (from the `tikz-cd` package) so that it can be used with the `uncentered rectangle` shape.

Q: [50]

This library provides only one key.

```
/tikz-ext/tikz-cd fix
```

(style, no value)

This key installs various “fixes” to the `/tikz/commutative diagrams/every diagram` style:

- Firstly, it defines a `/tikz/matrix of math nodes` key (only for the `tikzcd` environment) which allows to toggle the `/tikz/commutative diagrams/math` mode for

each node.⁸

- The helpful macro `\unrec` will be installed.

`\unrec{<left>}{<center>}{<right>}`

When used as the content of `uncentered rectangle`, the node parts will be setup so that `<left>` is in the left part of the node part etc.

- Since math mode will be disabled with the `uncentered rectangle`, it is automatically enabled for each node part with `\unrec` but it can be disabled with the following key.

`/tikz/unrec math mode=<true> or <false>` (default true)

When enabled the contents of `\unrec` will be set in math mode.

- For easy access to the `uncentered rectangle` shape, the following keys are available inside a Commutative Diagram.

`/tikz/unrec=<left> or <text> or <right> or <real>` (style, no default, initially text)

This key sets the shape to `uncentered rectangle` and `/pgf/uncentered rectangle center` to its argument.

`/tikz/commutative diagrams/install uncentered rectangle in column=<column>` (style, no default)

All nodes in column `<column>` will be set to the `uncentered rectangle` shape.

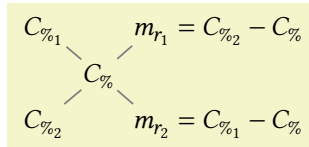

```
\usetikzlibrary {cd, ext.shapes.uncenteredrectangle}
\tikzcdset{/tikz-ext/tikz-cd fix}
\newcommand*\C[1]{C_{\%_{#1}}}
\begin{tikzcd}
\end{tikzcd}
[
  sep=tiny,
  arrows={-, gray},
  cells={font=\strut, inner xsep=.2ex, inner ysep=.1ex},
  install uncentered rectangle in column=3
]
\C{1} \drar & & \unrec{m_{r_1}} = \C{2}-C_{\%} \dlar \\
& C_{\%} & \\
\C{2} \urar & & \unrec{m_{r_2}} = \C{1}-C_{\%} \ular
\end{tikzcd}
```

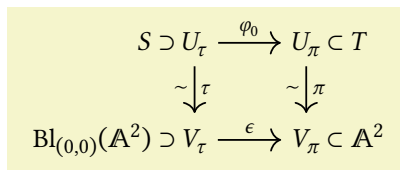

```
\usetikzlibrary {cd, ext.shapes.uncenteredrectangle}
\tikzset{/tikz-ext/tikz-cd fix}
\begin{tikzcd}[install uncentered rectangle in column/.list={1,2}]
\unrec{S \supset }{U_{\tau}} \xrightarrow[r]{\varphi_0}
& \unrec{U_{\pi}} \subset T & \\
& & \xrightarrow[d]{\tau, \sim} \\
\unrec{\operatorname{Bl}_{(0,0)}(\mathbb{A}^2) \supset }{V_{\tau}} \xrightarrow[r]{\epsilon}
& \unrec{V_{\pi}} \subset \mathbb{A}^2 & \\
& & \xrightarrow[d]{\pi, \sim}
\end{tikzcd}
```

⁸Due to a bug with `/tikz/execute at end node`, the “automatic” math mode in matrices can’t be used with multipart nodes.

Part IV

Utilities

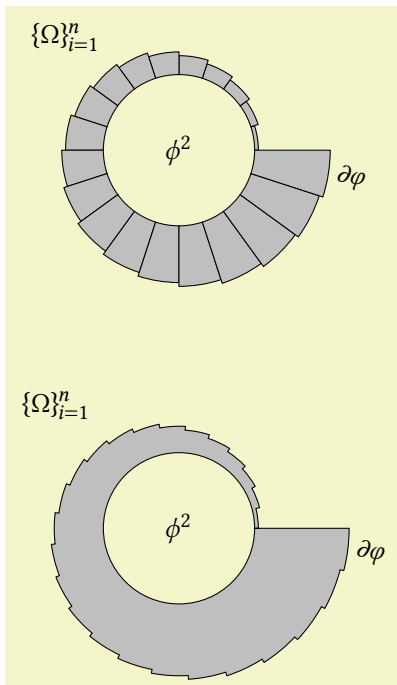

```

\usetikzlibrary {ext.misc}
\begin{tikzpicture}[
  declare function={bigR(\n)=smallR+.05*\n;},
  declare constant={smallR=1; segments=20;},
  full arc=segments]
\foreach \iN[evaluate={\endRadius=bigR(\iN+1);}, use int=0 to segments-1]
\filldraw[fill=gray!50] (\iN R:\endRadius)
  arc [radius=\endRadius, start angle=\iN R, delta angle=+IR] -- (\iN R+IR:smallR)
  arc [radius=smallR, end angle=\iN R, delta angle=-IR] -- cycle;

\node at (0,0) {\phi^2};
\node at (north west:{sqrt 2 * bigR(segments/2)}) {\Omega_{i=1}^n};
\node[rotate=-.5R, right] at (-.5R: bigR segments) {\partial \varphi};

\tikzset{yshift=-5cm, declare constant={segments=25;}, full arc=segments}
\filldraw[fill=gray!50] (right:smallR)
  \foreach \iN[evaluate={\endRadius=bigR(\iN+1);}, use int=0 to segments-1] {
    -- (\iN R:\endRadius) arc[radius=\endRadius, start angle=\iN R, delta angle=IR]}
  -- (right:smallR) arc[radius=smallR, start angle=0, delta angle=-360];

\node at (0,0) {\phi^2};
\node at (north west:{sqrt 2 * bigR(segments/2)}) {\Omega_{i=1}^n};
\node[rotate=-.5R, right] at (-.5R: bigR segments) {\partial \varphi};
\end{tikzpicture}

```

24 Calendar: Weeknumbers and more conditionals

```
\usepackage{calendar-ext} % LATEX
\input calendar-ext.tex % plain TEX
```

This package adds week numbers and more conditionals to the PGF package pgfcalendar.

Q & A: [10, 11, 15] & [26, 46, 32]

24.1 Extensions

The following tests are added.

- **Jan** This test is passed by all dates that are in the month of January.
- **Feb** as above.
- **Mar** as above.
- **Apr** as above.
- **May** as above.
- **Jun** as above.
- **Jul** as above.
- **Aug** as above.
- **Sep** as above.
- **Oct** as above.
- **Nov** as above.
- **Dec** as above.
- **leap year= $\langle year \rangle$** This test checks whether the given year is a leap year. If $\langle year \rangle$ is omitted, it checks the year of the current date.
- **and= $\{\langle tests \rangle\}$** This test passes when all $\langle tests \rangle$ pass.
- **not= $\{\langle tests \rangle\}$** This test passes when $\langle tests \rangle$ do not pass.
- **week of month= $\langle num \rangle$** This test passes when the date is in $\langle num \rangle$ th week of the month. The first week of the month start at day 1 and ends with day 7.

- **week of month'= $\langle num \rangle$** As above but counts from the last day of the month. For a month with 31 days, this means the “1st” week starts at day 25 and ends with day 31.
- **calendar week of month= $\langle num \rangle$** This test passes when the date is in $\langle num \rangle$ th calendar week of the month. The first week starts at the first day of the month and ends at the next Sunday.
- **calendar week of month'= $\langle num \rangle$** As above but counts from the last day of the month.

<pre> 1 2 3 4 5 6 7 8 9 10 11 12 13 14 15 16 17 18 19 20 21 22 23 24 25 26 27 28 29 30 31 </pre>	<pre> \usetikzlibrary {ext.calendar-plus} \tikz \calendar[dates=2022-10-01 to 2022-10-31, week list] if (week of month=2) [red] if (calendar week of month'=2) [blue]; </pre>
--	--

- **yesterday= $\{\langle tests \rangle\}$** This test passes when the previous day passes $\langle tests \rangle$.
- **week= $\langle num \rangle$** This test passes when the current week of the year equals $\{\langle num \rangle\}$.

The shorthands for d- and m- are slightly changed so that they are expandable. This makes it possible to use these shorthands inside of PGFmath. The shorthands for the week (see section 24.2) are added. These are

- n- (shortest numerical representation),
- n= (shortest but added horizontal space) and
- n0 (leading zero when below 10).

24.2 Week numbering (ISO 8601)

`\pgfcalendarjulianyeartoweek`{*Julian day*}{*year*}{*week count*}

This command calculates the week for the *Julian day* of *year*. The *week counter* must be a TeX count.

The calculation follows the rule of ISO 8601 where the first week has that year's first Thursday in it.

Inside of `\pgfcalendar` the command `\pgfcalendarcurrentweek` will be available.

`\pgfcalendarcurrentweek`

This command returns the current week number (always two digits – use shorthand `n.` to strip the leading zero).

Inside of `\ifdate` the command `\pgfcalendarifdateweek` will be available.

`\pgfcalendarifdateweek`

This command returns the week number (always two digits).

25 Repeating Things and Other Things

```
\usepackage{pgffor-ext} % LATEX
\input pgffor-ext.tex % plain TEX
```

This package adds small niceties to the pgffor package. Most of these additions are also available with the ext.misc library.

Warning: Consider this package experimental. At the very least, it will break the . . . notation and possibly gobbles spaces after the body.

Q & A: [1, 7, 53] & [35, 41, 37]

Instead of `\foreach \var in {start, start + delta, ..., end}` one can use `\foreach \var[use int=start to end step delta]`.

`/pgf/foreach/use int=<start>to<end>step<delta>` (no default)

The values `<start>`, `<end>` and `<delta>` are evaluated by pgfmath at initialization. The part `step <delta>` is optional (`<delta> = 1`).

`/pgf/foreach/use float=<start>to<end>step<delta>` (no default)

Same as above, however the results are not truncated.

`/pgf/foreach/no separator` (no value)

This key disables any separator between elements of the list. Every token is its own element. This also means that Unicode characters need to be grouped between `{` and `}` if Lua_T_E_X isn't used. Spaces will be ignored.

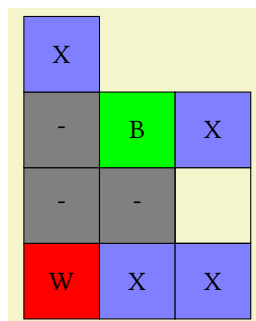

```
\usetikzlibrary {ext.misc}
\newcommand*{\board}[3][[]]{%
  \begin{tikzpicture}[#1]
    \foreach[
      count=i from 0,
      no separator,
      evaluate=i as \colX using {mod(\i,#2)},
      evaluate=i as \rowY using {int(\i/#2)}
    ] \elem in {#3} {
      \draw[black, board/\elem/.try, rectangle timer/.try=line]
        (\colX,\rowY) rectangle node {\elem} ++(1, 1);}
  \end{tikzpicture}}
\board[
  board/W/.style={fill=red},
  board/X/.style={fill=blue!50},
  board/B/.style={fill=green},
  board/-/.style={fill=gray},
]{3}{WXX---BXX}
```

`/pgf/foreach/normal list` (no value)

This key simply disables all other special parsers and returns to the original list parser.

The following keys only work with \LaTeX and cannot be used when only the `ext.misc` library or the plain \TeX `pgffor-ext.tex` are loaded. For this, you will need to use `\usepackage{pgffor-ext}`.

`/pgf/foreach/xparser={\langle argument specification \rangle}{\langle foreach value \rangle}` (no default)

This key can be used to specify a `xparse` specification for each element in the list.

For this to work somewhat seamless, the following needs to be observed:

- Every `{\langle argument specification \rangle}` gets appended with `u,`. This means there's always one additional mandatory argument at the end of every element.
- The `{\langle foreach value \rangle}` needs to correspond to the `/pgf/foreach/var` value.

`/pgf/foreach/xparser Om` (no value)

Sets up a list whose elements may contain an optional argument inside `[]` which correspond to two `\foreach` variables, say `\Options/\Text`.

Key handler `\langle key \rangle/.list xparse={\langle argument specification \rangle}{\langle comma-separated list of values \rangle}`

This handler causes the key to be used repeatedly, namely once for every element of the list of values. The `\langle comma-separated list of values \rangle` is processed using `\foreach` and the given `xparse` `\langle argument specification \rangle` with the aforementioned `xparser` key.

26 And a little bit more

TikZ Library `ext.misc`

```
\usetikzlibrary{ext.misc} % LATEX and plain TEX
\usetikzlibrary[ext.misc] % ConTEXt
```

This library adds miscellaneous utilities to PGFmath, PGF or TikZ.

Q & A: [22] & [25]

26.1 PGFmath

26.1.1 Postfix operator R

Similar to `\segments[<num>]` in PSTricks, the postfix operator R allows the user to use an arbitrary number of segments of a circle to be used instead of an angle.

```
/pgf/full arc=<num> (default {})
```

The number `<num>` of segments will be set up. Using `full arc` with an empty value disables the segmentation and `1R` equals 1° .

The given value `<num>` is evaluated when the key is used and doesn't change when `<num>` contains variables that change.

The R operator can then be used.

`xR` (postfix operator; uses the `fullarc` function)

Multiplies x with $\frac{360}{\langle num \rangle}$.

26.1.2 Functions

```
strrepeat("Text", x)
```

```
\pgfmathstrrepeat{"Text"}{x}
```

Returns a string with `Text` repeated x times.

```
foofoofoofoofoo \pgfmathparse{strrepeat("foo", 5)}
\pgfmathresult
```

```
isInString("String", "Text")
\pgfmathisInString{"String"}{"Text"}
```

Returns 1 (true) if `Text` contains `String`, otherwise 0 (false).

```
0 and 1 \pgfmathparse{isInString("foo", "bar")}
\pgfmathresult \ and\
\pgfmathparse{isInString("foo", "foobar")}
\pgfmathresult
```

```
strcat("Text A", "Text B", ...)
\pgfmathstrcat{"Text A"}{"Text B"}{...}
```

Returns the concatenation of all given parameters.

```
blue!21!green \pgfmathparse{strcat("blue!", int(7*3), "!green")}
\pgfmathresult
```

```
isEmpty("Text")
\pgfmathisEmpty{"Text"}
```

Returns 1 (true) if `Text` is empty, otherwise 0 (false).

```
0 and 1 and 1 \pgfmathparse{isEmpty("foo")} \pgfmathresult\ and\
\pgfmathparse{isEmpty("")} \pgfmathresult\ and\
\def\emptyText{}
\pgfmathparse{isEmpty("\emptyText")} \pgfmathresult
```

```
atanXY(x, y)
```

`\pgfmathatanXY{x}{y}`

Arctangent of $y \div x$ in degrees. This also takes into account the quadrant. This is just a argument-swapped version of `atan2` which makes it easier to use the `\p` commands of the `calc` library.

```
53.13011 \pgfmathparse{atanXY(3,4)} \pgfmathresult
```

`atanYX(y,x)`

`\pgfmathatanYX{y}{x}`

Arctangent of $y \div x$ in degrees. This also takes into account the quadrant.

```
53.13011 \pgfmathparse{atanYX(4,3)} \pgfmathresult
```

26.1.3 Functions: using coordinates

The following functions can only be used with PGF and/or TikZ. Since the arguments are usually plain text (and not numbers) one has to wrap them in `"`.

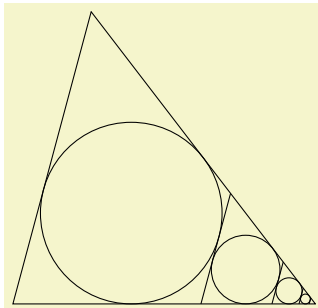

```
\usetikzlibrary {calc,ext.misc,through}
\begin{tikzpicture}
\path (0,0) coordinate (A) + (0:4) coordinate (B) +(75:4) coordinate (C);
\draw (A) -- (B) -- (C) -- cycle;
\foreach \cnt in {1,...,4}{
  \pgfmathsetmacro\triA{distancebetween("B","C")}
  \pgfmathsetmacro\triB{distancebetween("C","A")}
  \pgfmathsetmacro\triC{distancebetween("A","B")}
  \path (barycentric cs:A=\triA,B=\triB,C=\triC) coordinate (M)
  node [draw, circle through=($(A)!(M)!(C)$)] (M) {};
  \draw ($(C)-(A)$) coordinate (vecB)
  (M.75-90) coordinate (@)
  (intersection of @--[shift=(vecB)]@ and B--C) coordinate (C) --
  (intersection of @--[shift=(vecB)]@ and B--A) coordinate (A);}
\end{tikzpicture}
```

26.2 PGFfor

This library loads also most of the functions of the `pgffor-ext` of section 25 on page 63.

`anglebetween("p1", "p2")`

`\pgfmathanglebetween{"p1"}{"p2"}`

Return the angle between the centers of the nodes `p1` and `p2`.

`qanglebetween("p")`

`\pgfmathqanglebetween{"p"}`

Return the angle between the origin and the center of the node `p`.

`distancebetween("p1", "p2")`

`\pgfmathdistancebetween{"p1"}{"p2"}`

Return the distance (in pt) between the centers of the nodes `p1` and `p2`.

`qdistancebetween("p")`

`\pgfmathqdistancebetween{"p"}`

Return the distance (in pt) between the origin and the center of the node `p`.

26.3 PGFkeys

pgfkeys Library `ext.pgfkeys-plus`

```
\usepgfkeyslibrary{ext.pgfkeys-plus} % LATEX and plain TEX
\usepgfkeyslibrary[ext.pgfkeys-plus] % ConTEXt
```

This extends `pgfkeys` and adds helpful `/utils` keys as well as handlers. This library gets loaded by the `ext.misc` library.⁹

26.3.1 Conditionals

`/utils/if={⟨cond⟩}{⟨true⟩}{⟨false⟩}` (no default)

This key checks the conditional `⟨cond⟩` and applies the styles `⟨true⟩` if `⟨cond⟩` is true, otherwise `⟨false⟩`. `⟨cond⟩` can be anything that `PGFmath` understands.

As a side effect on how `PGFkeys` parses argument, the `⟨false⟩` argument is actually optional.

The following keys use T_EX' macros `\if`, `\ifx`, `\ifnum` and `\ifdim` for faster executions.

`/utils/TeX/if=⟨token A⟩⟨token B⟩{⟨true⟩}{⟨false⟩}` (no default)

This key checks via `\if` if `⟨token A⟩` matches `⟨token B⟩` and applies the styles `⟨true⟩` if it does, otherwise `⟨false⟩`.

As a side effect on how `PGFkeys` parses argument, the `⟨false⟩` argument is actually optional.

`/utils/TeX/ifx=⟨token A⟩⟨token B⟩{⟨true⟩}{⟨false⟩}` (no default)

As above but via `\ifx`.

`/utils/TeX/ifnum={⟨num cond⟩}{⟨true⟩}{⟨false⟩}` (no default)

This key checks `\ifnum⟨num cond⟩` and applies the styles `⟨true⟩` if true, otherwise `⟨false⟩`. A delimiting `\relax` will be inserted after `⟨num cond⟩`.

As a side effect on how `PGFkeys` parses arguments, the `⟨false⟩` argument is actually optional.

`/utils/TeX/ifdim=⟨dim cond⟩⟨true⟩⟨false⟩` (no default)

As above but with `\ifdim`.

`/utils/TeX/ifempty=⟨Text⟩⟨true⟩⟨false⟩` (no default)

This checks whether `⟨Text⟩` is empty and applies styles `⟨true⟩` if true, otherwise `⟨false⟩`.

`/utils/TeX/ifxempty=⟨Text⟩⟨true⟩⟨false⟩` (no default)

This checks whether fully expanded `⟨Text⟩` is empty and applies styles `⟨true⟩` if true, otherwise `⟨false⟩`.

26.3.2 Handlers

While already a lot of values given to keys are evaluated by `PGFmath` at some point, not all of them are.

Key handler `⟨key⟩/.pgfmath=⟨eval⟩`

This handler evaluates `⟨eval⟩` before it is handed to the key.

This handler works almost the same as the `.evaluated` handler but it does its evaluation in a group so that the result will not overwrite any other results.

Key handler `⟨key⟩/.pgfmath int=⟨eval⟩`

As above but truncates the result.

Key handler `⟨key⟩/.pgfmath wrap={⟨wrapper⟩}{⟨eval⟩}`

This feeds the result of `⟨eval⟩` as #1 to `⟨wrapper⟩`.

In the example below, one could have used the `/pgf/foreach/evaluate` key from the `\foreach` loop.

⁹`\usepgfkeyslibrary` is an upcoming feature of `PGF/TikZ`. For now, you need to load `ext.misc` or manually `\input` the file `pgfkeyslibraryext.pgfkeys-plus.code.tex` with @ being a letter.

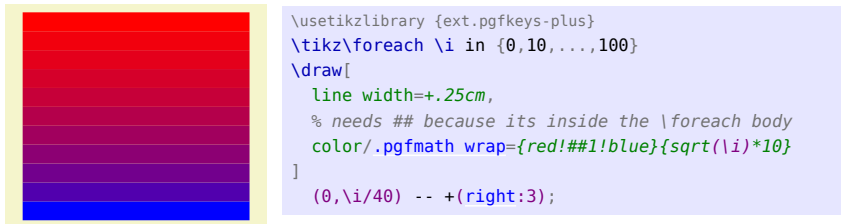

Key handler $\langle key \rangle /.pgfmath\ if=\langle cond \rangle \{ \langle true \rangle \} \{ \langle false \rangle \}$

Evaluates $\langle cond \rangle$ with PGFMath and returns $\langle true \rangle$ or $\langle false \rangle$ to the used key respectively.

Key handler $\langle key \rangle /.if=\langle token A \rangle \langle token B \rangle \{ \langle true \rangle \} \{ \langle false \rangle \}$

Checks via \if if $\langle token A \rangle$ matches $\langle token B \rangle$ and applies the value $\langle true \rangle$ if it does, otherwise $\langle false \rangle$.

Key handler $\langle key \rangle /.ifx=\langle token A \rangle \langle token B \rangle \{ \langle true \rangle \} \{ \langle false \rangle \}$

As above but via \ifx .

Key handler $\langle key \rangle /.ifnum=\langle ifnum cond \rangle \{ \langle true \rangle \} \{ \langle false \rangle \}$

Checks via \ifnum if $\langle ifnum cond \rangle$ and applies the value $\langle true \rangle$ if it does, otherwise $\langle false \rangle$.

Key handler $\langle key \rangle /.ifdim=\langle ifdim cond \rangle \{ \langle true \rangle \} \{ \langle false \rangle \}$

As above but via \ifdim .

Key handler $\langle key \rangle /.ifxempty=\langle Text \rangle \{ \langle true \rangle \} \{ \langle false \rangle \}$

Checks whether a fully expanded $\langle Text \rangle$ is empty and applies the value $\langle true \rangle$ if it does, otherwise $\langle false \rangle$.

Key handler $\langle key \rangle /.ifempty=\langle Text \rangle \{ \langle true \rangle \} \{ \langle false \rangle \}$

Checks whether $\langle Text \rangle$ is empty and applies the value $\langle true \rangle$ if it does, otherwise $\langle false \rangle$.

Key handler $\langle key \rangle /.List=\langle \langle e1 \rangle, \langle e2 \rangle, \dots, \langle en \rangle \rangle$

This handler evaluates the given list with \foreach and concatenates the element and the result is then given to the used key.

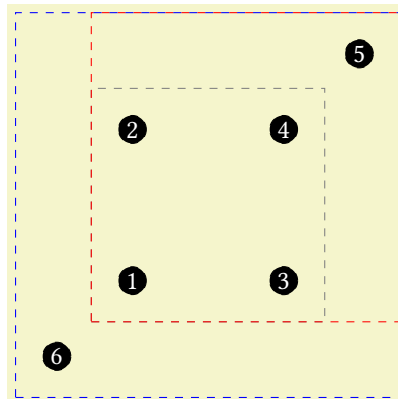

```

\usetikzlibrary {fit,ext.misc}
\begin{tikzpicture}[nodes={draw, dashed, inner sep=+10pt}]
\foreach \point [count=\cnt] in {(0,0), (0,2), (2,0), (2,2), (3,3), (-1,-1)}
\node[circle, fill, inner sep=1pt, text=white] (point-\cnt) at \point {\cnt};
\node[gray, fit/.List={(point-1), (point-...), (point-4)}] {};
\node[red, fit/.List={(point-1), (point-...), (point-5)}] {};
\node[blue, fit/.List={(point-1), (point-...), (point-6)}] {};
\end{tikzpicture}

```

26.4 TikZ

`/tikz/reverse clip=<direction>` (default counter clockwise)

This key installs a very big rectangle which is either constructed counter clockwise (like the circle path operation) or clockwise.

`/tikz/clip rule=<direction>` (default even odd)

This key switches directly¹⁰ to the specified rule which is either even odd or nonzero. This corresponds to the `/tikz/even odd rule` and `/tikz/nonzero rule` keys.

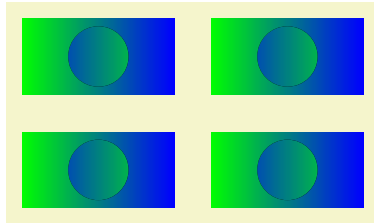

```
\usetikzlibrary {ext.misc}
\newcommand*\myDiagram[1]{
  \fill[left color=blue, right color=green] (0, 0) rectangle (2, 1);
  \clip (1, .5) #1 [reverse clip];
  \fill[left color=green, right color=blue] (0, 0) rectangle (2, 1);
}
\begin{tikzpicture}[radius=.4, row sep=5mm, column sep=5mm]
\matrix[
  row 2/.append style={clip rule=even odd},
  column 1/.append style={reverse clip/.default=clockwise}
]{
  \myDiagram{circle[]} &
  \myDiagram{+(0:.4) arc[start angle=0, delta angle=-360] -- cycle}
\\
  \myDiagram{circle[]} &
  \myDiagram{+(0:.4) arc[start angle=0, delta angle=-360] -- cycle}
\\};
\end{tikzpicture}
```

¹⁰Meaning, it directly executes `\pgfseteorule` /`\pgfsetnonzerorule` and doesn't accumulate where TikZ throws an error.

Part V

Changelog, Index & References

Changelog

Version 0.5.1

- Added PGF library `ext.arrows`.
- Bugfix to `ext.pgfkeys-plus`. [20]

Version 0.5

- Added package `pgffor-ext`.
- Added TikZ library `ext.nodes`.
- Added TikZ library `ext.layers`.
- Bugfixes to `ext.calendar-plus`.
- Allow the original rectangle timer with `ext.paths.timer`.

Version 0.4.2

- Added TikZ library `ext.scalepicture`.
- Bugfixes to `shapes.uncenteredrectangle`, `paths.ortho`, `positioning-plus` and `pgfcalendar-ext`.

Version 0.4.1

- Cleaned up directory structure of documentary.
- Added PGFkeys library `ext.pgfkeys-plus`.
- Added shape `uncentered rectangle` (PGF library `ext.shapes.uncenteredrectangle`).
- Fixed `ext.paths.arcto` – again [19].

Version 0.4

- CTAN version of 0.3.1

Version 0.3.1

- Fixed `ext.paths.ortho` keys only `vertical first` and only `horizontal first`.
- Moved all (except the `to paths`) to namespace `/tikz/ortho`. `/tikz/hvvh` and `/tikz/udlr` are considered deprecated.
- Fixed `\pgfcalendarjulianyeartoweek`.
- Added more calendar tests.
- Added directory structure.

Version 0.3

- Added shape `circle arrow` (PGF library `ext.shapes.circlearrow`).
- Added shape `circle cross split` (PGF library `ext.shapes.circlecrosssplit`).
- Added shape `heatmark` (PGF library `ext.shapes.heatmark`).
- Added shape `rectangle with rounded corners` (PGF library `ext.shapes.rectangleroundedcorners`).
- Added shape `superellipse` (PGF library `ext.shapes.superellipse`).
- Added TikZ library `ext.node-families.shapes.geometric`.
- Fixed `ext.node-families'` key size.

- Renamed internal macros to use custom namespace starting with `\tikzext@`.
- Added some references.

Version 0.2

- Added TikZ library `ext.positioning-plus`.
- Added TikZ library `ext.node-families`.

Version 0.1

- Added TikZ library `ext.calendar-plus`.
- Added TikZ library `ext.misc`.

- Added TikZ library `ext.paths.arcto`.
- Added TikZ library `ext.paths.ortho`.
- Added TikZ library `ext.paths.timer`.
- Added TikZ library `ext.patterns.images`.
- Added TikZ library `ext.topaths.arctthrough`.
- Added TikZ library `ext.transformations.mirror`.
- Added PGF library `ext.transformations.mirror`.

Index

This index contains automatically generated entries as well as [references](#) to original functionalities of `PGF/TikZ` and [references](#) to functionalities outside of `PGF/TikZ`.

- path operation, [12](#)
 - |-| path operation, [16](#)
 - |- path operation, [16](#)
 - | path operation, [16](#)
 - | path operation, [16](#)

 - above key, [27](#)
 - above left key, [25](#)
 - above right key, [25](#)
 - and date test, [61](#)
 - anglebetween math function, [66](#)
 - Apr date test, [61](#)
 - arc path operation, [43](#)
 - Arc Barb arrow tip, [38, 39](#)
 - arc through key, [32](#)
 - arc to path operation, [14](#)
 - Arrow tips
 - Arc Barb, [38, 39](#)
 - Bar, [38, 39](#)
 - Bracket, [38, 39](#)
 - Centered Arc Barb, [38, 39](#)
 - Centered Bar, [38](#)
 - Centered Bracket, [38](#)
 - Centered Circle, [38](#)
 - Centered Diamond, [38](#)
 - Centered Ellipse, [38](#)
 - Centered Hooks, [38](#)
 - Centered Kite, [38](#)
 - Centered Parenthesis, [38](#)
 - Centered Rays, [38](#)
 - Centered Rectangle, [38](#)
 - Centered Square, [38](#)
 - Centered Stealth, [38](#)
 - Centered Straight Barb, [38](#)
 - Centered Tee Barb, [38](#)
 - Centered Triangle, [38](#)

 - Centered Turned Square, [38](#)
 - Circle, [38, 39](#)
 - Diamond, [38](#)
 - Ellipse, [38, 39](#)
 - Hooks, [38](#)
 - Hug Cap, [39](#)
 - Kite, [38](#)
 - Loop, [39](#)
 - Parenthesis, [38, 39](#)
 - Rays, [38](#)
 - Rectangle, [38](#)
 - Square, [38](#)
 - Stealth, [38](#)
 - Straight Barb, [38](#)
 - Tee Barb, [38, 39](#)
 - Triangle, [38](#)
 - Turned Square, [38](#)
 - Untipped Bar, [39](#)
 - Untipped Bracket, [39](#)
 - Untipped Circle, [39](#)
 - Untipped Ellipse, [39](#)
 - Untipped Parenthesis, [39](#)
 - Untipped Tee Barb, [39](#)
- arrows.meta library, [37](#)
- atan2 math function, [41, 66](#)
- atanXY math function, [65](#)
- atanYX math function, [66](#)
- Aug date test, [61](#)
-
- background code key, [8](#)
- Bar arrow tip, [38, 39](#)
- below key, [27](#)
- below left key, [25](#)
- below right key, [25](#)
- Bracket arrow tip, [38, 39](#)

- calc library, 66
- calendar library, 7
- calendar week of month date test, 61
- calendar week of month' date test, 61
- calendar-ext package, 61
- cd library, 57, 58
- center suffix key, 32
- Centered Arc Barb arrow tip, 38, 39
- Centered Bar arrow tip, 38
- Centered Bracket arrow tip, 38
- Centered Circle arrow tip, 38
- Centered Diamond arrow tip, 38
- Centered Ellipse arrow tip, 38
- Centered Hooks arrow tip, 38
- Centered Kite arrow tip, 38
- Centered Parenthesis arrow tip, 38
- Centered Rays arrow tip, 38
- Centered Rectangle arrow tip, 38
- Centered Square arrow tip, 38
- Centered Stealth arrow tip, 38
- Centered Straight Barb arrow tip, 38
- Centered Tee Barb arrow tip, 38
- Centered Triangle arrow tip, 38
- Centered Turned Square arrow tip, 38
- Circle arrow tip, 38, 39
- circle path operation, 69
- circle shape, 9
- circle arrow shape, 43
- circle arrow arrows key, 43
- circle arrow delta angle key, 43
- circle arrow end angle key, 43
- circle arrow start angle key, 43
- circle arrow turn left east key, 43
- circle arrow turn left north key, 43
- circle arrow turn left south key, 43
- circle arrow turn left west key, 43
- circle arrow turn right east key, 44
- circle arrow turn right north key, 44
- circle arrow turn right south key, 44
- circle arrow turn right west key, 44
- circle cross split shape, 46

- circle cross split part fill key, 46
- circle cross split uses custom fill key, 46
- clip rule key, 69
- clockwise key, 14, 32
- code key, 8
- corner above left key, 25
- corner above right key, 25
- corner below left key, 25
- corner below right key, 25
- corner east above key, 28
- corner east below key, 28
- corner north left key, 28
- corner north right key, 28
- corner south left key, 28
- corner south right key, 28
- corner west above key, 28
- corner west below key, 28
- cos math function, 41
- cos path operation, 22
- counter clockwise key, 15, 32

Date tests

- and, 61
- Apr, 61
- Aug, 61
- calendar week of month, 61
- calendar week of month', 61
- Dec, 61
- Feb, 61
- Jan, 61
- Jul, 61
- Jun, 61
- leap year, 61
- Mar, 61
- May, 61
- not, 61
- Nov, 61
- Oct, 61
- Sep, 61
- week, 61
- week of month, 61

- week of month', 61
 - yesterday, 61
- day code key, 7
- day text key, 7
- day xshift key, 7
- day yshift key, 7
- Dec date test, 61
- Diamond arrow tip, 38
- distance key, 16
- distancebetween math function, 66
- du distance key, 18

- east above key, 27
- east below key, 27
- edge path operation, 32
- edge in box key, 8
- edge on layer key, 8
- Ellipse arrow tip, 38, 39
- Environments
 - pgfonlayer, 8
 - tikzcd, 58
- evaluate key, 67
- .evaluated handler, 67
- even odd rule key, 69
- every arc to key, 15
- every day key, 7
- every diagram key, 58
- every month key, 7
- every week key, 7
- execute at end node key, 59
- execute at end picture key, 9
- ext.arrows library, 37
- ext.calendar-plus library, 7
- ext.layers library, 8
- ext.misc library, 63–65
- ext.node-families library, 9
- ext.node-families.shapes.geometric library, 11
- ext.nodes library, 12
- ext.paths.arcto library, 14
- ext.paths.ortho library, 16
- ext.paths.timer library, 21

- ext.patterns.images library, 24
- ext.pgfkeys-plus pgfkeys library, 67
- ext.positioning-plus library, 25
- ext.scalepicture library, 30
- ext.shapes.circlearrow library, 43
- ext.shapes.circlecrosssplit library, 46
- ext.shapes.heatmark library, 49
- ext.shapes.rectangleroundedcorners library, 52
- ext.shapes.superellipse library, 54
- ext.shapes.uncenteredrectangle library, 57, 58
- ext.topaths.arcthrough library, 32
- ext.transformations.mirror library, 33, 41
- external library, 9

- Feb date test, 61
- fit library, 25
- fit bounding box key, 29
- foreground code key, 8
- from center key, 17
- full arc key, 65

- heatmark shape, 49
- heatmark arc $\langle arc\ number \rangle$ key, 50
- heatmark arc rings key, 49
- heatmark arc sep key, 49
- heatmark arc sep angle key, 49
- heatmark arc width key, 49
- heatmark arcs key, 49
- heatmark inner opacity key, 49
- heatmark outer opacity key, 49
- heatmark ring $\langle ring\ number \rangle$ key, 49
- heatmark ring $\langle ring\ number \rangle$ arc $\langle arc\ number \rangle$ key, 50
- height key, 10, 11
- Hooks arrow tip, 38
- horizontal vertical key, 19
- horizontal vertical horizontal key, 19
- Hug Cap arrow tip, 39

- .if handler, 68
- if key, 7, 67
- \ifdate, 62

- .ifdim handler, 68
- ifdim key, 67
- .ifempty handler, 68
- ifempty key, 67
- .ifnum handler, 68
- ifnum key, 67
- .ifx handler, 68
- ifx key, 67
- .ifxempty handler, 68
- ifxempty key, 67
- image as pattern key, 24
- in box key, 8
- install shortcuts key, 20
- install uncentered rectangle in columns key, 59
- intersections library, 13
- isEmpty math function, 65
- isInString math function, 65

- Jan date test, 61
- Jul date test, 61
- Jun date test, 61

Key handlers

- .List, 68
- .evaluated, 67
- .if, 68
- .ifdim, 68
- .ifempty, 68
- .ifnum, 68
- .ifx, 68
- .ifxempty, 68
- .list xparse, 64
- .pgfmath, 67
- .pgfmath if, 68
- .pgfmath int, 67
- .pgfmath wrap, 67

- Kite arrow tip, 38

- Large key, 15
- lastdayinmonthofyear math function, 7
- leap year date test, 61

- left key, 26, 27
- length key, 39

Libraries

- arrows.meta, 37
- calc, 66
- calendar, 7
- cd, 57, 58
- ext.arrows, 37
- ext.calendar-plus, 7
- ext.layers, 8
- ext.misc, 63–65
- ext.node-families, 9
- ext.node-families.shapes.geometric, 11
- ext.nodes, 12
- ext.paths.arcto, 14
- ext.paths.ortho, 16
- ext.paths.timer, 21
- ext.patterns.images, 24
- ext.positioning-plus, 25
- ext.scalepicture, 30
- ext.shapes.circulararrow, 43
- ext.shapes.circlexsplit, 46
- ext.shapes.heatmark, 49
- ext.shapes.rectangleroundedcorners, 52
- ext.shapes.superellipse, 54
- ext.shapes.uncenteredrectangle, 57, 58
- ext.topaths.arctthrough, 32
- ext.transformations.mirror, 33, 41
- external, 9
- fit, 25
- intersections, 13
- markings, 12
- positioning, 25
- shapes.geometric, 11
- spath3, 13

- .List handler, 68
- .list xparse handler, 64
- Loop arrow tip, 39
- lr distance key, 18

- Mar date test, 61

mark connection node key, 12
markings library, 12
Math functions
 anglebetween, 66
 atan2, 41, 66
 atanXY, 65
 atanYX, 66
 cos, 41
 distancebetween, 66
 isEmpty, 65
 isInString, 65
 lastdayinmonthofyear, 7
 qanglebetween, 66
 qdistancebetween, 66
 sin, 41
 strcat, 65
 strrepeat, 65
 superellipse, 55
 superellipse, 55
 weeksmonthofyear, 7
math mode key, 58
Math operators
 R, 65
matrix in box key, 8
matrix of math nodes key, 58
matrix on layer key, 8
maximum picture height key, 30
maximum picture size key, 30
maximum picture width key, 30
maximum picture width* key, 31
May date test, 61
middle 0 to 1 key, 18
minimum height key, 10, 29
minimum picture height key, 30
minimum picture size key, 30
minimum picture width key, 30
minimum picture width* key, 31
minimum width key, 10, 29
Mirror key, 35
mirror key, 34
Mirror x key, 35

mirror x key, 34
Mirror y key, 35
mirror y key, 34
month code key, 7
month text key, 7
month xshift key, 7
month yshift key, 7

name key, 24
no separator key, 63
node in box key, 8
node on layer key, 8
node on line key, 12
nodes on curve key, 13
nodes on curve' key, 13
nodes on line key, 12, 13
nonzero rule key, 69
normal list key, 63
north left key, 26
north right key, 27
not date test, 61
Nov date test, 61

Oct date test, 61
on grid key, 29
on layer key, 8
only horizontal first key, 19
only horizontal second key, 19
only vertical first key, 19
only vertical second key, 19
option key, 24
options key, 24
outer sep key, 13

Packages and files
 calendar-ext, 61
 pgffor, 63
 pgffor-ext, 63, 66
 xparse, 64
parabola path operation, 22
Parenthesis arrow tip, 38, 39

patch key, 8
Path operations

- , 12
- |-|, 16
- |-, 16
- |, 16
- |-, 16
- arc, 43
- arc to, 14
- circle, 69
- cos, 22
- edge, 32
- parabola, 22
- r-du, 18
- r-lr, 18
- r-rl, 18
- r-ud, 18
- rectangle, 21
- sin, 22
- to, 32

/pgf/

- arrow keys/
 - length, 39
- circle arrow arrows, 43
- circle arrow delta angle, 43
- circle arrow end angle, 43
- circle arrow start angle, 43
- circle arrow turn left east, 43
- circle arrow turn left north, 43
- circle arrow turn left south, 43
- circle arrow turn left west, 43
- circle arrow turn right east, 44
- circle arrow turn right north, 44
- circle arrow turn right south, 44
- circle arrow turn right west, 44
- circle cross split part fill, 46
- circle cross split uses custom fill, 46
- decoration/
 - mark connection node, 12
- foreach/
 - evaluate, 67

- no separator, 63
- normal list, 63
- use float, 63
- use int, 63
- var, 64
- xparser, 64
- xparser 0m, 64
- full arc, 65
- heatmark arc (*arc number*), 50
- heatmark arc rings, 49
- heatmark arc sep, 49
- heatmark arc sep angle, 49
- heatmark arc width, 49
- heatmark arcs, 49
- heatmark inner opacity, 49
- heatmark outer opacity, 49
- heatmark ring (*ring number*), 49
- heatmark ring (*ring number*) arc (*arc number*), 50
- minimum height, 10, 29
- minimum width, 10, 29
- outer sep, 13
- rectangle with rounded corners north east radius, 52
- rectangle with rounded corners north west radius, 52
- rectangle with rounded corners radius, 52
- rectangle with rounded corners south east radius, 52
- rectangle with rounded corners south west radius, 52
- shape border rotate, 49
- superellipse exponent, 54
- superellipse step, 54
- superellipse x exponent, 54
- superellipse y exponent, 54
- text, 24
- uncentered rectangle center, 57, 59
- uncentered rectangle center yshift, 57
- uncentered rectangle use saved center, 57

\pgfcalendar, 62

\pgfcalendarcurrentweek, 62

\pgfcalendarifdateweek, 62

\pgfcalendarjulianyartowee, 62

pgffor package, 63

pgffor-ext package, 63, 66

- pgfkeys Libraries
 - ext.pgfkeys-plus, 67
- .pgfmath handler, 67
- .pgfmath if handler, 68
- .pgfmath int handler, 67
- .pgfmath wrap handler, 67
- \pgfmathanglebetween, 66
- \pgfmathanglebetweenpoints, 41
- \pgfmathatanXY, 66
- \pgfmathatanYX, 66
- \pgfmathdistancebetween, 66
- \pgfmathisEmpty, 65
- \pgfmathisInString, 65
- \pgfmathlastdayinmonthofyear, 7
- \pgfmathqanglebetween, 66
- \pgfmathqdistancebetween, 66
- \pgfmathstrcat, 65
- \pgfmathstrrepeat, 65
- \pgfmathsuperellipse, 55
- \pgfmathsuperellipseXY, 55
- \pgfmathsuperellipseY, 55
- \pgfmathweeksInmonthofyear, 7
- pgfonlayer environment, 8
- \pgfpatharcto, 15
- \pgfpointrnormalised, 41
- \pgfqtransformMirror, 42
- \pgfqtransformmirror, 42
- \pgfsetarrows, 43
- \pgfseteorule, 69
- \pgfsetnonzerorule, 69
- \pgfsetupimageaspattern, 24
- \pgftext, 24
- \pgftransformMirror, 42
- \pgftransformmirror, 42
- \pgftransformxMirror, 41
- \pgftransformxmirror, 41
- \pgftransformyMirror, 42
- \pgftransformymirror, 42
- \pgfutil@prefix@macrotomacro, 55
- pic key, 12
- pic in box key, 8

- pic on layer key, 8
- picture height key, 30
- picture height* key, 31
- picture size* key, 31
- picture width key, 30
- picture width* key, 30
- pos key, 17, 21
- positioning library, 25
- prefix key, 9

- qanglebetween math function, 66
- qdistancebetween math function, 66

- R postfix math operator, 65
- r-du path operation, 18
- r-lr path operation, 18
- r-rl path operation, 18
- r-ud path operation, 18
- radius key, 15
- ratio key, 16
- Rays arrow tip, 38
- Rectangle arrow tip, 38
- rectangle path operation, 21
- rectangle shape, 9
- rectangle timer key, 21
- rectangle with rounded corners shape, 52
- rectangle with rounded corners north east radius key, 52
- rectangle with rounded corners north west radius key, 52
- rectangle with rounded corners radius key, 52
- rectangle with rounded corners south east radius key, 52
- rectangle with rounded corners south west radius key, 52
- reverse clip key, 69
- right key, 27
- rl distance key, 18
- rotate key, 15

- save picture size key, 30
- Sep date test, 61
- setup shape key, 10
- shape border rotate key, 49
- Shapes

- circle, 9
- circle arrow, 43
- circle cross split, 46
- heatmark, 49
- rectangle, 9
- rectangle with rounded corners, 52
- superellipse, 54
- uncentered rectangle, 57
- shapes.geometric library, 11
- sin math function, 41
- sin path operation, 22
- size key, 10
- small key, 15
- south left key, 27
- south right key, 27
- spacing key, 17
- span key, 29
- span horizontal key, 29
- span vertical key, 29
- spath3 library, 13
- Square arrow tip, 38
- Stealth arrow tip, 38
- Straight Barb arrow tip, 38
- strcat math function, 65
- strrepeat math function, 65
- superellipse shape, 54
- superellipse exponent key, 54
- superellipse step key, 54
- superellipse x exponent key, 54
- superellipse y exponent key, 54
- superellipsex math function, 55
- superellipsey math function, 55
- Tee Barb arrow tip, 38, 39
- text key, 24
- text key, 9
- text depth key, 9
- text height key, 9
- text width key, 9
- text width align key, 10
- through key, 32

- /tikz/
 - above, 27
 - above left, 25
 - above right, 25
 - arc through/
 - center suffix, 32
 - clockwise, 32
 - counter clockwise, 32
 - through, 32
 - arc through, 32
 - arc to/
 - clockwise, 14
 - counter clockwise, 15
 - large, 15
 - radius, 15
 - rotate, 15
 - small, 15
 - x radius, 15
 - y radius, 15
 - below, 27
 - below left, 25
 - below right, 25
 - clip rule, 69
 - commutative diagrams/
 - every diagram, 58
 - install uncentered rectangle in columns, 59
 - math mode, 58
 - corner above left, 25
 - corner above right, 25
 - corner below left, 25
 - corner below right, 25
 - corner east above, 28
 - corner east below, 28
 - corner north left, 28
 - corner north right, 28
 - corner south left, 28
 - corner south right, 28
 - corner west above, 28
 - corner west below, 28
 - day code, 7
 - day text, 7

- day xshift, 7
- day yshift, 7
- east above, 27
- east below, 27
- edge in box, 8
- edge on layer, 8
- even odd rule, 69
- every arc to, 15
- every day, 7
- every month, 7
- every week, 7
- execute at end node, 59
- execute at end picture, 9
- fit bounding box, 29
- horizontal vertical, 19
- horizontal vertical horizontal, 19
- if, 7
- image as pattern/
 - name, 24
 - option, 24
 - options, 24
- image as pattern, 24
- left, 26, 27
- matrix in box, 8
- matrix of math nodes, 58
- matrix on layer, 8
- maximum picture height, 30
- maximum picture size, 30
- maximum picture width, 30
- maximum picture width*, 31
- minimum picture height, 30
- minimum picture size, 30
- minimum picture width, 30
- minimum picture width*, 31
- Mirror, 35
- mirror, 34
- Mirror x, 35
- mirror x, 34
- Mirror y, 35
- mirror y, 34
- month code, 7

- month text, 7
- month xshift, 7
- month yshift, 7
- node family/
 - height, 10, 11
 - prefix, 9
 - setup shape, 10
 - size, 10
 - text, 9
 - text depth, 9
 - text height, 9
 - text width, 9
 - text width align, 10
 - width, 10, 11
- node in box, 8
- node on layer, 8
- node on line, 12
- nodes on curve, 13
- nodes on curve', 13
- nodes on line, 12, 13
- nonzero rule, 69
- north left, 26
- north right, 27
- on grid, 29
- only horizontal first, 19
- only horizontal second, 19
- only vertical first, 19
- only vertical second, 19
- ortho/
 - distance, 16
 - du distance, 18
 - from center, 17
 - install shortcuts, 20
 - lr distance, 18
 - middle 0 to 1, 18
 - ratio, 16
 - rl distance, 18
 - spacing, 17
 - ud distance, 18
 - udlr distance, 18
- pic, 12

- pic in box, 8
- pic on layer, 8
- pics/
 - background code, 8
 - code, 8
 - foreground code, 8
- picture height, 30
- picture height*, 31
- picture size*, 31
- picture width, 30
- picture width*, 30
- pos, 17, 21
- rectangle timer, 21
- reverse clip, 69
- right, 27
- save picture size, 30
- south left, 27
- south right, 27
- span, 29
- span horizontal, 29
- span vertical, 29
- to path, 12, 19
- unrec, 59
- unrec math mode, 59
- vertical horizontal, 19
- vertical horizontal vertical, 19
- week code, 7
- week label left, 7
- week text, 7
- west above, 27
- west below, 27
- x radius, 15
- xMirror, 35
- xmirror, 33
- y radius, 15
- yMirror, 35
- ymirror, 34
- tikz-cd fix key, 58
- /tikz-ext/
 - layers/
 - in box, 8

- on layer, 8
 - patch, 8
 - tikz-cd fix, 58
- tikzcd environment, 58
- \tikzextpictureheight, 30
- \tikzextpicturewidth, 30
- to path operation, 32
- to path key, 12, 19
- Triangle arrow tip, 38
- Turned Square arrow tip, 38

- ud distance key, 18
- udlr distance key, 18
- uncentered rectangle shape, 57
- uncentered rectangle center key, 57, 59
- uncentered rectangle center yshift key, 57
- uncentered rectangle use saved center key, 57
- \unrec, 59
- unrec key, 59
- unrec math mode key, 59
- Untipped Bar arrow tip, 39
- Untipped Bracket arrow tip, 39
- Untipped Circle arrow tip, 39
- Untipped Ellipse arrow tip, 39
- Untipped Parenthesis arrow tip, 39
- Untipped Tee Barb arrow tip, 39
- use float key, 63
- use int key, 63
- /utils/
 - if, 67
 - TeX/
 - if, 67
 - ifdim, 67
 - ifempty, 67
 - ifnum, 67
 - ifx, 67
 - ifxempty, 67

- var key, 64
- vertical horizontal key, 19
- vertical horizontal vertical key, 19

week date test, [61](#)
week code key, [7](#)
week label left key, [7](#)
week of month date test, [61](#)
week of month' date test, [61](#)
week text key, [7](#)
weeks_in_month_of_year math function, [7](#)
west above key, [27](#)
west below key, [27](#)
width key, [10](#), [11](#)

x radius key, [15](#)
x radius key, [15](#)
xMirror key, [35](#)
xmirror key, [33](#)
xparse package, [64](#)
xparser key, [64](#)
xparser Om key, [64](#)

y radius key, [15](#)
y radius key, [15](#)
yesterday date test, [61](#)
yMirror key, [35](#)
ymirror key, [34](#)

References

- [1] Foo Bar. *How to use declared TikZ functions in \foreach condition?* TeX - LaTeX Stack Exchange. Apr. 2013. URL: <https://tex.stackexchange.com/q/110962> (visited on 09/24/2022) (cit. on p. 63).
- [2] boje. *Heatmap over country like Google Map.* May 2013. URL: <https://tex.stackexchange.com/q/112929> (visited on 09/24/2022) (cit. on p. 49).
- [3] Christian. *TikZ arrow tip is displaced.* TeX - LaTeX Stack Exchange. Apr. 2013. URL: <https://tex.stackexchange.com/q/111051> (visited on 04/02/2023) (cit. on p. 37).
- [4] cis. *TikZ / calendar: Set the height of a monthly calendar.* Dec. 2018. URL: <https://tex.stackexchange.com/q/464589> (visited on 09/24/2022) (cit. on p. 7).
- [5] cis. *TikZ: How to place a coordinate at parabola-path-position?* May 2020. URL: <https://tex.stackexchange.com/q/543251> (visited on 09/24/2022) (cit. on p. 21).
- [6] CrazyArm. *Is It Possible to Combine TikZ Distance and Line-To Operations?* Apr. 2013. URL: <https://tex.stackexchange.com/q/106558> (visited on 09/24/2022) (cit. on p. 21).
- [7] daan. *String conditional tikz.* TeX - LaTeX Stack Exchange. Nov. 2022. URL: <https://tex.stackexchange.com/q/666263> (visited on 12/03/2022) (cit. on p. 63).
- [8] Alejandro DC. *Better fitting line to node in TikZ.* TeX - LaTeX Stack Exchange. Apr. 2015. URL: <https://tex.stackexchange.com/q/241074> (visited on 04/01/2023) (cit. on p. 37).
- [9] Dimitris. *Draw two concentric circles and a shaded area with associated text.* TeX - LaTeX Stack Exchange. Dec. 2022. URL: <https://tex.stackexchange.com/q/667338> (visited on 12/12/2022) (cit. on p. 12).
- [10] Fence. *Add week day to calendar.* Nov. 2019. URL: <https://tex.stackexchange.com/q/517338> (visited on 09/24/2022) (cit. on pp. 7, 61).
- [11] healyp. *TikZ calendar and conditional tests.* Oct. 2013. URL: <https://tex.stackexchange.com/q/140948> (visited on 09/24/2022) (cit. on pp. 7, 61).
- [12] Jan Hlavacek. *Modifying * and o style tikz arrows so that they are centered at the end of line.* TeX - LaTeX Stack Exchange. Feb. 2011. URL: <https://tex.stackexchange.com/q/11871> (visited on 04/02/2023) (cit. on p. 37).
- [13] Holene. *Dependent node size in TikZ.* Apr. 2017. URL: <https://tex.stackexchange.com/q/107227> (visited on 09/24/2022) (cit. on p. 9).
- [14] Edgar A. Bering IV. *Set the color of a tikz-cd Glyph arrow tip with xelatex.* TeX - LaTeX Stack Exchange. Oct. 2020. URL: <https://tex.stackexchange.com/q/565010> (visited on 04/01/2023) (cit. on p. 37).
- [15] jd6. *Full weeks in Tikz Calendar.* TeX - LaTeX Stack Exchange. Dec. 2020. URL: <https://tex.stackexchange.com/q/576673> (visited on 10/09/2022) (cit. on p. 61).
- [16] knut. *TikZ: Define pattern with reference to external picture.* Mar. 2013. URL: <https://tex.stackexchange.com/q/103980> (visited on 09/24/2022) (cit. on p. 24).
- [17] Ben Liblit. *path with both mark connection node and arrow tip.* TeX - LaTeX Stack Exchange. Feb. 2013. URL: <https://tex.stackexchange.com/q/99945> (visited on 12/12/2022) (cit. on p. 12).
- [18] Marco. *TikZ - Four Colored Circle Split.* Apr. 2017. URL: <https://tex.stackexchange.com/q/121686> (visited on 09/24/2022) (cit. on p. 46).
- [19] marmotghost. *clockwise/counter clockwise does not seem to work reliably.* Oct. 2022. URL: <https://github.com/Qrrbrlbel/tikz-extensions/issues/2> (visited on 10/23/2022) (cit. on p. 70).
- [20] marmotghost. *Latest version of ext.misc on CTAN appears to have a typo.* Mar. 2023. URL: <https://github.com/Qrrbrlbel/tikz-extensions/issues/6> (visited on 04/01/2023) (cit. on p. 70).

- [21] nkk. *How to prevent tikz custom node fill from covering the text when using node-families library*. June 2019. URL: <https://tex.stackexchange.com/q/494862> (visited on 09/24/2022) (cit. on p. 11).
- [22] Anthony Peter. *A rather difficult ring like picture to be drawn*. Apr. 2017. URL: <https://tex.stackexchange.com/q/144293> (visited on 09/24/2022) (cit. on p. 65).
- [23] projetmbc. *forest - automatic setting of the alignment of some labels*. TeX - LaTeX Stack Exchange. Oct. 2022. URL: <https://tex.stackexchange.com/q/661726> (visited on 10/23/2022) (cit. on p. 57).
- [24] projetmbc. *TikZ - "Circled" arrow*. TeX - LaTeX Stack Exchange. Jan. 2013. URL: <https://tex.stackexchange.com/q/95221> (visited on 09/24/2022) (cit. on p. 43).
- [25] Qrrrbirlbel. *Answer to "A rather difficult ring like picture to be drawn"*. Nov. 2013. URL: <https://tex.stackexchange.com/a/144297> (visited on 09/24/2022) (cit. on p. 65).
- [26] Qrrrbirlbel. *Answer to "Add week day to calendar"*. July 2022. URL: <https://tex.stackexchange.com/a/651888> (visited on 09/24/2022) (cit. on pp. 7, 61).
- [27] Qrrrbirlbel. *Answer to "An oval surrounded a *long text* inside in TikZ [equivalent cover background of METAFUN]"*. TeX - LaTeX Stack Exchange. Aug. 2022. URL: <https://tex.stackexchange.com/a/654759> (visited on 09/24/2022) (cit. on p. 54).
- [28] Qrrrbirlbel. *Answer to "Better fitting line to node in TiKZ"*. TeX - LaTeX Stack Exchange. Apr. 2015. URL: <https://tex.stackexchange.com/a/241303> (visited on 04/01/2023) (cit. on p. 37).
- [29] Qrrrbirlbel. *Answer to "Dependent node size in TikZ"*. June 2013. URL: <https://tex.stackexchange.com/a/121054> (visited on 09/24/2022) (cit. on p. 9).
- [30] Qrrrbirlbel. *Answer to "Draw two concentric circles and a shaded area with associated text"*. TeX - LaTeX Stack Exchange. Dec. 2022. URL: <https://tex.stackexchange.com/a/667341> (visited on 12/12/2022) (cit. on p. 12).
- [31] Qrrrbirlbel. *Answer to "forest - automatic setting of the alignment of some labels"*. TeX - LaTeX Stack Exchange. Oct. 2022. URL: <https://tex.stackexchange.com/a/661746> (visited on 10/23/2022) (cit. on p. 57).
- [32] Qrrrbirlbel. *Answer to "Full weeks in Tikz Calendar"*. TeX - LaTeX Stack Exchange. Oct. 2022. URL: <https://tex.stackexchange.com/a/660335> (visited on 10/09/2022) (cit. on p. 61).
- [33] Qrrrbirlbel. *Answer to "Heatmap over country like Google Map"*. May 2013. URL: <https://tex.stackexchange.com/a/113004> (visited on 09/24/2022) (cit. on p. 49).
- [34] Qrrrbirlbel. *Answer to "How to draw a mixing rule? #chemistry"*. TeX - LaTeX Stack Exchange. Sept. 2022. URL: <https://tex.stackexchange.com/a/657449> (visited on 10/23/2022) (cit. on p. 57).
- [35] Qrrrbirlbel. *Answer to "How to use declared TikZ functions in foreach condition?"* TeX - LaTeX Stack Exchange. Apr. 2013. URL: <https://tex.stackexchange.com/a/110996> (visited on 09/24/2022) (cit. on p. 63).
- [36] Qrrrbirlbel. *Answer to "Is It Possible to Combine TikZ Distance and Line-To Operations?"* Apr. 2013. URL: <https://tex.stackexchange.com/a/106571> (visited on 09/24/2022) (cit. on p. 21).
- [37] Qrrrbirlbel. *Answer to "Is there a package to implement this style of "Register diagrams with field descriptions"?"*. TeX - LaTeX Stack Exchange. Dec. 2022. URL: <https://tex.stackexchange.com/a/667155> (visited on 12/03/2022) (cit. on p. 63).
- [38] Qrrrbirlbel. *Answer to "Modifying * and o style tikz arrows so that they are centered at the end of line"*. TeX - LaTeX Stack Exchange. Sept. 2022. URL: <https://tex.stackexchange.com/a/656241> (visited on 04/02/2023) (cit. on p. 37).
- [39] Qrrrbirlbel. *Answer to "path with both mark connection node and arrow tip"*. TeX - LaTeX Stack Exchange. Dec. 2022. URL: <https://tex.stackexchange.com/a/667487> (visited on 12/12/2022) (cit. on p. 12).

- [40] Qrrbrbirlbel. *Answer to “Set the color of a tikz-cd Glyph arrow tip with xelatex”*. TeX - LaTeX Stack Exchange. Apr. 2023. URL: <https://tex.stackexchange.com/a/681474> (visited on 04/01/2023) (cit. on p. 37).
- [41] Qrrbrbirlbel. *Answer to “String conditional tikz”*. TeX - LaTeX Stack Exchange. Nov. 2022. URL: <https://tex.stackexchange.com/a/666265> (visited on 12/03/2022) (cit. on p. 63).
- [42] Qrrbrbirlbel. *Answer to “TikZ - ‘Circled’ arrow”*. TeX - LaTeX Stack Exchange. Jan. 2013. URL: <https://tex.stackexchange.com/a/95263> (visited on 09/24/2022) (cit. on p. 43).
- [43] Qrrbrbirlbel. *Answer to “TikZ - Four Colored Circle Split”*. June 2013. URL: <https://tex.stackexchange.com/a/121767> (visited on 09/24/2022) (cit. on p. 46).
- [44] Qrrbrbirlbel. *Answer to “TikZ / calendar: Set the height of a monthly calendar”*. Aug. 2022. URL: <https://tex.stackexchange.com/a/653146> (visited on 09/24/2022) (cit. on p. 7).
- [45] Qrrbrbirlbel. *Answer to “TikZ arrow tip is displaced”*. TeX - LaTeX Stack Exchange. Apr. 2013. URL: <https://tex.stackexchange.com/a/111053> (visited on 04/02/2023) (cit. on p. 37).
- [46] Qrrbrbirlbel. *Answer to “TikZ calendar and conditional tests”*. Oct. 2013. URL: <https://tex.stackexchange.com/a/141027> (visited on 09/24/2022) (cit. on pp. 7, 61).
- [47] Qrrbrbirlbel. *Answer to “TikZ: Define pattern with reference to external picture”*. Apr. 2013. URL: <https://tex.stackexchange.com/a/107144> (visited on 09/24/2022) (cit. on p. 24).
- [48] Qrrbrbirlbel. *Answer to “TikZ: How to place a coordinate at parabola-path-position?”* Nov. 2021. URL: <https://tex.stackexchange.com/a/621012> (visited on 09/24/2022) (cit. on p. 21).
- [49] somenxavier. *An oval surrounded a *long text* inside in TikZ [equivalent cover background of METAFUN]*. TeX - LaTeX Stack Exchange. Aug. 2022. URL: <https://tex.stackexchange.com/q/649144> (visited on 09/24/2022) (cit. on p. 54).
- [50] sro5h. *Achieve desired alignment of arrows in tikz-cd diagram*. TeX - LaTeX Stack Exchange. July 2022. URL: <https://tex.stackexchange.com/q/652540> (visited on 02/19/2023) (cit. on p. 58).
- [51] Andrew Stacey. *spath3 TikZ library*. original-date: 2014-05-26T12:08:12Z. Dec. 2022. URL: <https://github.com/loopspace/spath3> (visited on 12/10/2022) (cit. on p. 13).
- [52] Michał Szymankiewicz. *How to draw a mixing rule? #chemistry*. TeX - LaTeX Stack Exchange. Sept. 2022. URL: <https://tex.stackexchange.com/q/657432> (visited on 10/23/2022) (cit. on p. 57).
- [53] uulinux. *Is there a package to implement this style of “Register diagrams with field descriptions”*. TeX - LaTeX Stack Exchange. Oct. 2021. URL: <https://tex.stackexchange.com/q/618047> (visited on 12/03/2022) (cit. on p. 63).